

LINX[®] TECHNOLOGIES

MASTER EVALUATION/DEVELOPMENT SYSTEM

WIRELESS MADE SIMPLE[®]

MT Series Master Development System User's Guide

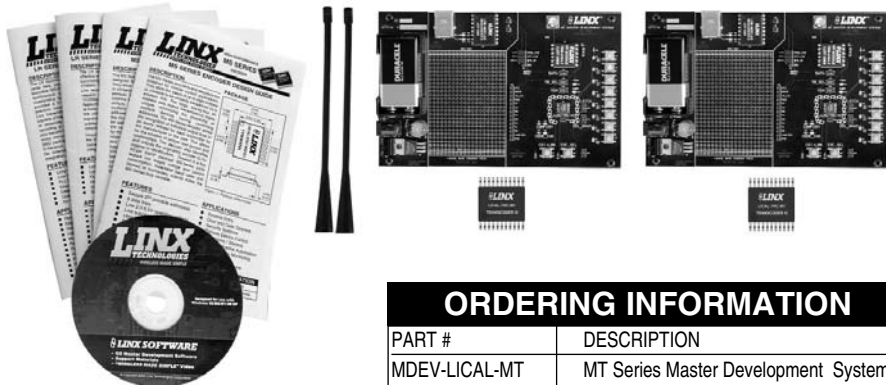

ORDERING INFORMATION	
PART #	DESCRIPTION
MDEV-LICAL-MT	MT Series Master Development System

INTRODUCTION

The MT Series transcoders are ideal for bi-directional remote control and command, security, keyless entry, status monitoring, and a host of similar applications. They allow the status of up to eight buttons or contacts to be securely transferred via a wireless link. The transcoder's rich feature set also allows it to meet the needs of far more complex applications. The Master Development System is intended to give a designer all the tools necessary to incorporate the transcoder into a product. This guide will show how to take full advantage of the development boards included with the system. Data Guides are included with the system or may be downloaded from the Linx Technologies website. The Master Development System serves several important functions:

- Rapid Evaluation - It allows the performance and features of the MT Series transcoder to be quickly evaluated.
- Design - It shows how to design with the transcoder and how to interface with other components. It also demonstrates the overall system function, making it easy to develop the initial system design.
- Prototype Development - It allows for additional circuitry to be placed directly on the board so that it can act as the first prototype of the product. All of the signals are available on a wire-wrap header for easy connection to external circuitry.

The Master Development System includes 2 fully assembled development boards, 4 MT Series transcoders*, and two CW Series antennas. The boards are also populated with the LT Series RF transceiver module and the QS Series USB module.

*One part is soldered to the board, one extra is for use on your first prototype board.

MT SERIES MASTER DEVELOPMENT BOARD

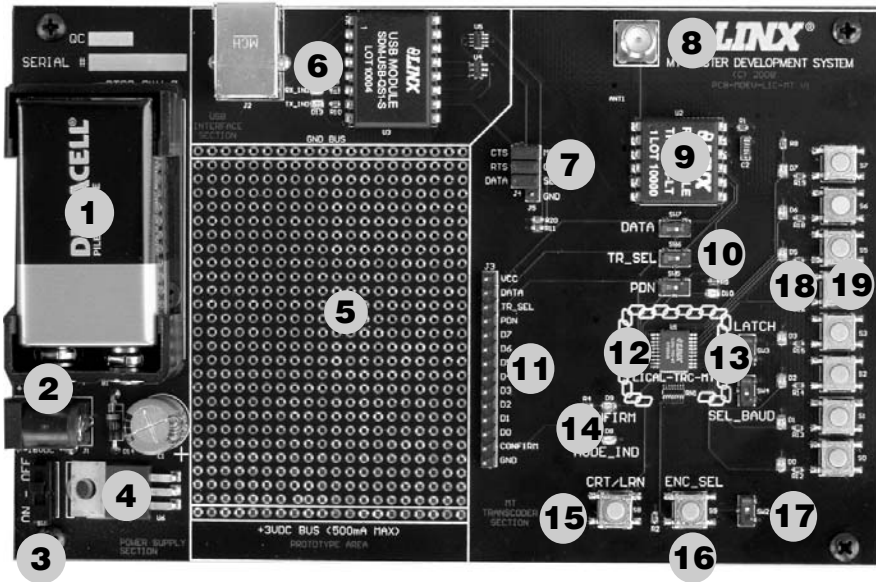

Figure 1: MT Series Master Development Board

1. 9V Battery
2. Power Jack
3. On-Off Switch
4. Voltage Regulator
5. Prototype Area
6. QS Series USB Module
7. USB Interface Jumpers
8. RP-SMA Antenna Connector
9. LT Series Transceiver
10. Routing Switches
11. Break-Out Header
12. MT Series Transcoder
13. Function Switches
14. Indicator LEDs
15. CRT/LRN Button
16. ENC_SEL Button
17. ENC_SEL Switch
18. Status Line LEDs
19. Status Line Buttons

USING THE DEVELOPMENT BOARDS

Use of the development system is straightforward. After unpacking the development boards, attach an antenna to each board, install the supplied 9V battery, and turn on the power switches. The transcoders will have default settings from the factory and will work straight out of the box. To create new addresses, follow these steps:

1. Press and hold the CRT/LRN and ENC_SEL buttons at the same time to enter Create Mode. The Address will be randomized for as long as the CRT/LRN button is held down (the ENC_SEL is not monitored once Create Mode has been entered). After a brief press, release the button.
2. Once the CRT/LRN button is released, the MODE_IND LED will begin to flash to indicate that it is ready to accept status line assignments. Press all of the status line buttons that are to be inputs, then press the CRT/LRN button again or let the transcoder time out after 15 seconds.
3. Press the CRT/LRN button on the other board and the MODE_IND LED will start flashing. On the transmitting side, press each of the status line buttons that are to be authorized. The receiving transcoder will record the Address of the transmitting transcoder. It will record each status line activation as the Control Permissions. Press the CRT/LRN button again or let the transcoder time out after 15 seconds to exit Learn Mode.
4. Repeat steps 1 through 3 for the other board.

TROUBLESHOOTING

If the boards fail to work out of the box, then try the following:

- Check the battery to make sure it is not dead.
- Make sure that the baud rate switches are set the same on both boards.
- Make sure that the antenna is connected and has the correct polarity connector.
- Make sure that status lines are set correctly. The transcoder will not activate a status line if it has been set as an input, so a status line that is an input on one board needs to be set as an output on the other board.
- Make sure that you set your Control Permissions correctly. If you have not set the transcoder to use a particular line, then when you press that line's button on one board, the MODE_IND LED on the other board will light up, but the status line LED will not light up.

If all of these appear to be in order, then you can call 800-736-6677 or email techsupport@linxtechnologies.com for technical support.

THE POWER SUPPLY

The power supply consists of a standard 9V battery and a power jack connected to a 3.0V voltage regulator. The regulator can provide approximately 500mA of current to the prototyping area. If the added circuitry will need more than this, then the designer must add an external supply. If the circuit will consistently draw more than 100mA of current, it might be better to use the power jack, as the battery may run down fairly quickly, reducing testing and development time.

The jack accepts a standard 5.5mm plug with the tip ground and the outer shell 7 to 16VDC positive supply. A reverse voltage protection diode has been included on the board to protect the circuitry in case the voltage on the plug is reversed, but it is still a good idea to double-check the polarity.

THE PROTOTYPING AREA

The prototyping area contains an area of plated through holes so that external circuitry can be placed on the board. This circuitry can be interfaced with the transcoder through the breakout header to the right. At the bottom is a row connected to the 3V power supply and at the top is a row connected to ground.

All of the status lines are connected to a wire-wrap header to the right, allowing easy access from the prototyping area. The TR_DATA, TR_SEL, TR_PDN and CONFIRM lines are also available on the header. This allows complete control of the entire system from the prototyping area.

THE USB AREA

The development boards have a Linx SDM-USB-QS-S module for use with a PC. This module is powered by the USB bus so no current is drawn from the battery. The figure below shows this section.

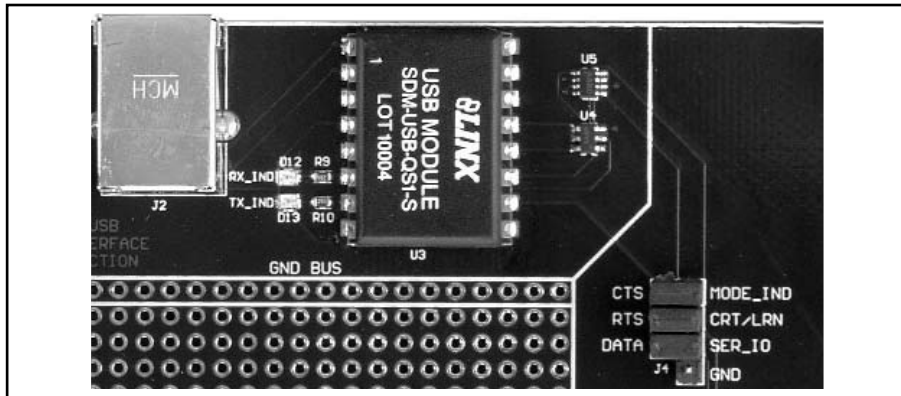

Figure 2: The USB Area

The jumpers to the right connect the USB module to the transcoder when the USB interface is in use and should be disconnected when not in use. U4 is a switch that connects the SER_IO line on the transcoder to either the RXD or TXD lines on the USB module based on the state of the RTS line. U5 is a level translator that converts the 5V signals from the USB module to 3V for the transcoder and vice versa. The RX_IND LED to the left of the module will flash when data is being received from the PC, and the TX_IND line will flash when the module is sending data to the PC.

THE TRANSCODER AREA

The figure below shows the transcoder area of the development board.

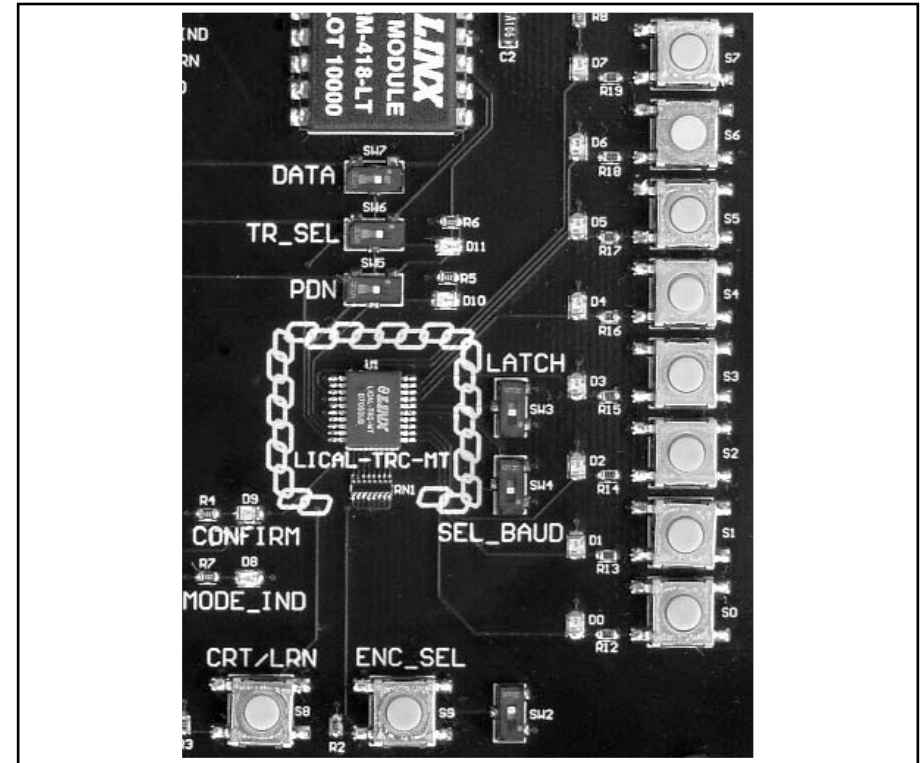

Figure 3: The Transcoder Area

The transcoder is placed in the center of the chain logo. To the right are two function switches. SEL_BAUD sets the baud rate of the transcoder. If the switch is up, the baud rate will be 28,800bps; if down, the baud rate will be 9,600bps. ***Important*** Both transcoders must be set to the same baud rate. The on-board transceiver is only capable of operation at 9,600bps.

If the LATCH switch is up, then the status lines are latched. If the switch is down, then the status lines are momentary.

To the right of the function switches is a column of status line LEDs and a column of status line buttons. Each status line has one LED and one button, so button S0 and LED D0 correspond to status line D0, S1 and D1 to line D1 and so forth. Pressing a button takes the status line high when the line is set as an input. The LED will activate when the line goes high when it is set as an output.

There is no isolation between the LEDs and the buttons, so the LED will activate when the button is pressed. Resistors are included for short circuit protection if the button is pressed for a line that is an output which is being pulled low.

Beneath the transcoder are two LEDs. D8 is connected to the MODE_IND line and will light up as described in the MT Transcoder Data Guide. D9 is connected to the CONFIRM line and will light up when the transcoder receives a valid confirmation from a remote unit.

THE TRANSCODER AREA (CONT)

Beneath the LEDs is a button that is connected to the CRT/LRN line. This button is used to create the Address, set the Control Permissions, and learn an address as described in the MT Series Transcoder Data Guide.

Next to the CRT/LRN button is a button connected to the ENC_SEL line. This button is used with the CRT/LRN button to create the Address and set the Control Permissions. Next to the button is a switch that will take the ENC_SEL line high so that the transcoder can be placed into Encoder Only mode. If the switch is up, then the line is controlled by the button. If the switch is down, then the line is connected to Vcc.

THE RF AREA

The figure below shows the RF area of the development board.

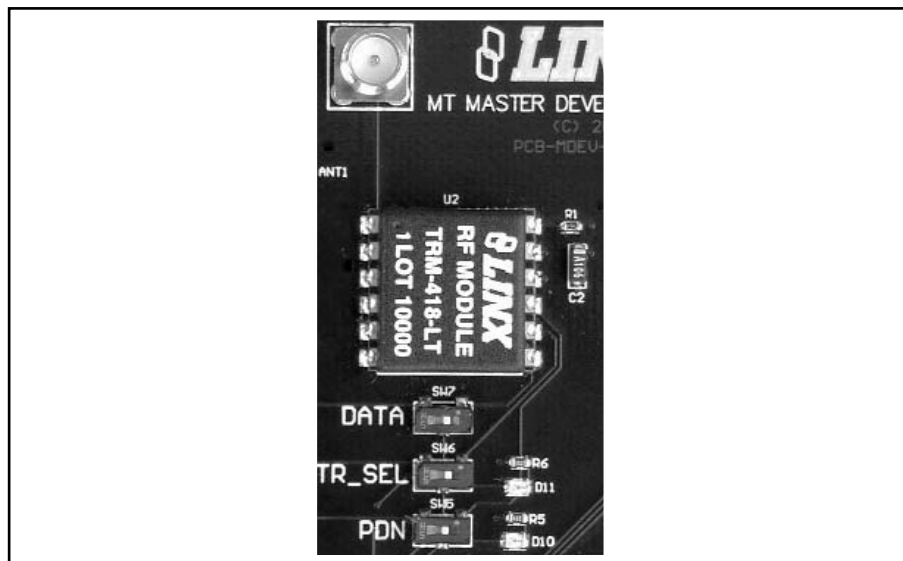

Figure 4: The RF Area

This board uses the LT Series transceiver for the wireless link. R1 is connected to the LADJ line of the transceiver to reduce the output power to the approximate limit of Part 15.231 of the FCC regulations. For applications where Part 15 limits are not applicable or output levels can be legally raised, R1 can be changed according to the graph on Page 4 of the LT Series Transceiver Data Guide.

The three switches below the transceiver connect the TR_DATA, TR_SEL and TR_PD_N lines to either the transceiver or the break out header in the Prototyping Area. This will prevent collisions on the lines resulting from connecting the transcoder, transceiver, and external circuitry to the same lines. If the switches are to the left, then the transcoder is connected to the header; if they are to the right, the transcoder is connected to the transceiver. Pads have been placed for LEDs to indicate the states of the TR_SEL and PDN lines. These indicators can be useful for debugging during development, but have been left to the user to populate if desired.

MT SERIES MASTER DEVELOPMENT SYSTEM SOFTWARE

The MS Series Master Development System software can be used in one of two modes. The default mode provides basic control of the transcoder through the serial interface engine.

The second mode is for full development of software designed to control the transcoder through the SIE. It shows all of the commands, the packets sent to the transcoder and the responses from the transcoder as well as a full view of the transcoder's memory bank. This allows full access and control of the transcoder, aiding in product development.

Both modes interface to the development boards through the USB module, demonstrating the simplicity of the hardware / software interface. Clicking a button on one computer causes the development board to activate, sending a command to the other development board. The other board then outputs the command to another computer where an action takes place, demonstrating the power and simplicity of the MT Series system.

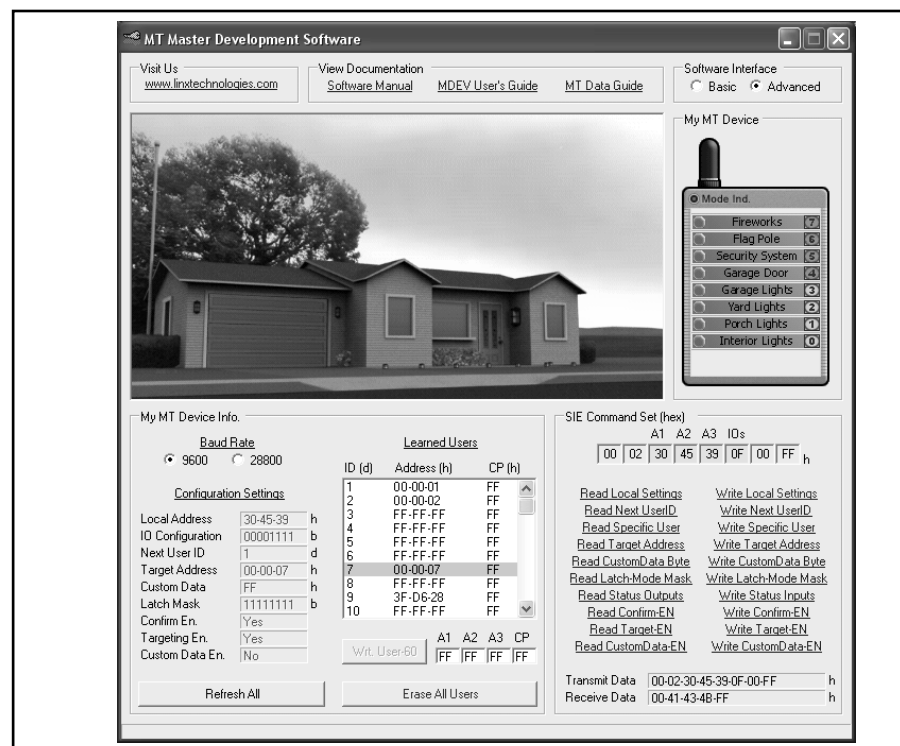

Figure 5: The MT Series Master Development System Software

INSTALLING THE SOFTWARE AND DRIVERS

The software included with the Master Development System uses the QS Series Direct Drivers and cannot be used with the Virtual COM Port Drivers. For this reason, only the Direct Drivers are included on the CD with the software.

The first time a QS module is plugged into a computer, Windows will display the Found New Hardware Wizard, which will guide you through installing the drivers. Application Note AN-00201 (Installing the SDM-USB-QS-S Drivers) describes the installation of the drivers in detail. The drivers should be installed before running the Development Software.

The MT Series Master Development System Software will automatically start when the CD is inserted and the player in the figure below will appear.

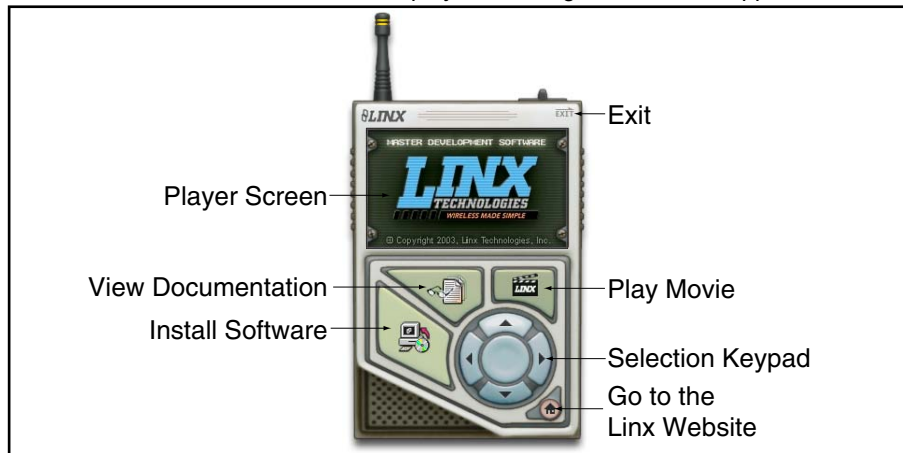

Figure 6: Software Installer

Clicking the Install Software button will start the Installation Wizard, which will guide you through the installation of the development software. The View Documentation button will show a list of the application notes and manuals related to the MT Series. Selecting one of these will open the file in Adobe Acrobat. The Play Movie button will play a short video about Linx in the Player Screen, which can be controlled with the Selection Keypad. Clicking the button on the bottom right of the player will open the Linx Technologies homepage in the computer's default browser.

The View Documentation list also allows for the installation of Adobe Acrobat Reader so that the documents may be viewed. There is also the option of installing Flash, which may be required if the Linx video does not play correctly.

The Read Me file found in the View Documentation list will have extra information on the software that may not be in the software documentation, so it is recommended that this file be read before using the software.

ONLINE RESOURCES



www.linxtechnologies.com

- Latest News
- Data Guides
- Application Notes
- Knowledgebase
- Software Updates



If you have questions regarding any Linx product and have Internet access, make www.linxtechnologies.com your first stop. Our website is organized in an intuitive format to immediately give you the answers you need. Day or night, the Linx website gives you instant access to the latest information regarding the products and services of Linx. It's all here: manual and software updates, application notes, a comprehensive knowledgebase, FCC information, and much more. Be sure to visit often!



www.antennafactor.com

The Antenna Factor division of Linx offers a diverse array of antenna styles, many of which are optimized for use with our RF modules. From innovative embeddable antennas to low-cost whips, domes to Yagis, and even GPS, Antenna Factor likely has an antenna for you, or can design one to meet your requirements.



www.connectorcity.com

Through its Connector City division, Linx offers a wide selection of high-quality RF connectors, including FCC-compliant types such as RP-SMAs that are an ideal match for our modules and antennas. Connector City focuses on high-volume OEM requirements, which allows standard and custom RF connectors to be offered at a remarkably low cost.





U.S. CORPORATE HEADQUARTERS

LINX TECHNOLOGIES, INC.

**159 ORT LANE
MERLIN, OR 97532**

PHONE: (541) 471-6256

FAX: (541) 471-6251

www.linxtechnologies.com

Disclaimer

Linx Technologies is continually striving to improve the quality and function of its products. For this reason, we reserve the right to make changes to our products without notice. The information contained in this Overview Guide is believed to be accurate as of the time of publication. Specifications are based on representative lot samples. Values may vary from lot-to-lot and are not guaranteed. "Typical" parameters can and do vary over lots and application. Linx Technologies makes no guarantee, warranty, or representation regarding the suitability of any product for use in any specific application. It is the customer's responsibility to verify the suitability of the part for the intended application. NO LINX PRODUCT IS INTENDED FOR USE IN ANY APPLICATION WHERE THE SAFETY OF LIFE OR PROPERTY IS AT RISK.

Linx Technologies DISCLAIMS ALL WARRANTIES OF MERCHANTABILITY AND FITNESS FOR A PARTICULAR PURPOSE. IN NO EVENT SHALL LINX TECHNOLOGIES BE LIABLE FOR ANY OF CUSTOMER'S INCIDENTAL OR CONSEQUENTIAL DAMAGES ARISING IN ANY WAY FROM ANY DEFECTIVE OR NON-CONFORMING PRODUCTS OR FOR ANY OTHER BREACH OF CONTRACT BY LINX TECHNOLOGIES. The limitations on Linx Technologies' liability are applicable to any and all claims or theories of recovery asserted by Customer, including, without limitation, breach of contract, breach of warranty, strict liability, or negligence. Customer assumes all liability (including, without limitation, liability for injury to person or property, economic loss, or business interruption) for all claims, including claims from third parties, arising from the use of the Products. The Customer will indemnify, defend, protect, and hold harmless Linx Technologies and its officers, employees, subsidiaries, affiliates, distributors, and representatives from and against all claims, damages, actions, suits, proceedings, demands, assessments, adjustments, costs, and expenses incurred by Linx Technologies as a result of or arising from any Products sold by Linx Technologies to Customer. Under no conditions will Linx Technologies be responsible for losses arising from the use or failure of the device in any application, other than the repair, replacement, or refund limited to the original product purchase price. Devices described in this publication may contain proprietary, patented, or copyrighted techniques, components, or materials. Under no circumstances shall any user be conveyed any license or right to the use or ownership of such items.