

High PSRR, Low Dropout, 400mA Adjustable LDO Regulator

General Description

The RT9043 is a high-performance, 400mA LDO regulator, offering high PSRR and low dropout. The quiescent current is as low as 35µA, further prolonging the battery life. The RT9043 also works with low-ESR ceramic capacitors, reducing the amount of board space necessary for power applications, critical in handheld wireless devices.

The RT9043 consumes typical 0.7µA in shutdown mode. The other features include low dropout voltage, high output accuracy, current limit protection, and enable/shutdown control. The RT9043 is available in the SOT-23-5 package.

Ordering Information

RT9043-□□

- Package Type
B : SOT-23-5
- Operating Temperature Range
G : Green (Halogen Free with Commercial Standard)

Note :

Richtek Green products are :

- ▶ RoHS compliant and compatible with the current requirements of IPC/JEDEC J-STD-020.
- ▶ Suitable for use in SnPb or Pb-free soldering processes.

Marking Information

For marking information, contact our sales representative directly or through a Richtek distributor located in your area, otherwise visit our website for detail.

Typical Application Circuit

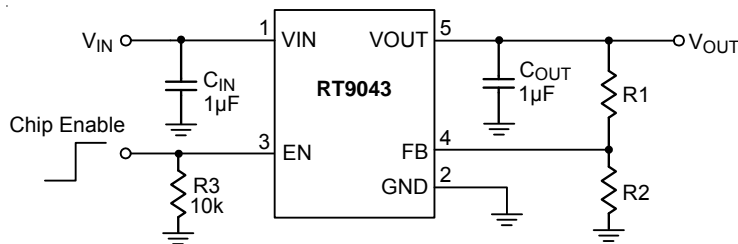

Features

- Adjustable Output Voltage
- Enable/Shutdown Control
- Wide Operating Voltage Range : 2.2V to 5.5V
- Low Dropout : 230mV at 400mA
- Low-Noise for RF Application
- Ultra-Fast Response in Line/Load Transient
- Current Limit Protection
- High Power Supply Rejection Ratio
- Output Only 1µF Capacitor Required for Stability
- RoHS Compliant and Halogen Free

Applications

- Mega SIM Card
- CDMA/GSM Cellular Handsets
- Portable Information Appliances
- Laptop, Palmtops, Notebook Computers
- Hand-Held Instruments
- Mini PCI & PCI-Express Cards
- PCMCIA & New Cards

Pin Configurations

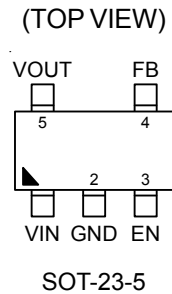

Function Block Diagram

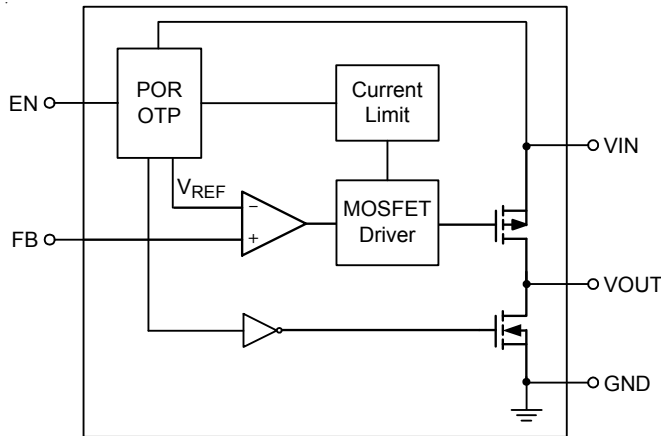

Functional Pin Description

Pin No.	Pin Name	Pin Function
1	VIN	Voltage Input.
2	GND	Ground.
3	EN	Chip Enable (Active High).
4	FB	Output Voltage Feedback.
5	VOUT	Voltage Output.

Absolute Maximum Ratings (Note 1)

- Supply Input Voltage, V_{IN} ----- 6V
- EN Input Voltage ----- 6V
- Power Dissipation, $P_D @ T_A = 25^\circ\text{C}$
SOT-23-5 ----- 0.4W
- Package Thermal Resistance (Note 4)
SOT-23-5, θ_{JA} ----- 250°C/W
- Lead Temperature (Soldering, 10 sec.) ----- 260°C
- Junction Temperature ----- 150°C
- Storage Temperature Range ----- -65°C to 150°C
- ESD Susceptibility (Note 2)
HBM ----- 2kV
MM ----- 200V

Recommended Operating Conditions (Note 3)

- Junction Temperature Range ----- -40°C to 125°C
- Ambient Temperature Range ----- -40°C to 85°C

Electrical Characteristics

($V_{IN} = 3.7V$, $C_{IN} = C_{OUT} = 1\mu F$, $I_{OUT} = 20mA$, $T_A = 25^\circ C$, unless otherwise specified)

Parameter		Symbol	Test Conditions	Min	Typ	Max	Units
Input Voltage Range		V_{IN}		2.2	--	5.5	V
Reference Voltage		V_{REF}		1.188	1.200	1.212	V
Quiescent Current		I_Q	$I_{OUT} = 0mA$	--	35	50	μA
Shutdown Current		I_{SHDN}	$V_{EN} = 0V$	--	0.7	1.5	μA
Current Limit		I_{LIM}	$R_{LOAD} = 0\Omega$, $2.2V \leq V_{IN} < 5.5V$	400	650	--	mA
Dropout Voltage		V_{DROP}	$I_{OUT} = 400mA$	--	230	350	mV
Load Regulation		ΔV_{LOAD}	$1mA < I_{OUT} < 400mA$ $2.2V \leq V_{IN} < 5.5V$	--	--	1	%
Line Regulation		ΔV_{LINE}	$V_{IN} = (V_{OUT} + 0.5V)$ to $5.5V$, $I_{OUT} = 1mA$	--	0.01	0.2	%/V
EN Threshold	Logic-Low Voltage	V_{IL}		0	--	0.6	V
	Logic-High Voltage	V_{IH}		1.6	--	5.5	
EN Pin Current		I_{EN}		--	0.1	1	μA
FB Pin Current		I_{FB}		--	0.1	1	μA
Power Supply Rejection Ratio		PSRR	$f = 1kHz$, $I_{OUT} = 10mA$	--	67	--	dB
			$f = 10kHz$, $I_{OUT} = 10mA$	--	56	--	dB
Output Noise Voltage		V_{ON}	$V_{OUT} = 1.5V$, $C_{OUT} = 1\mu F$, $I_{OUT} = 0mA$	--	30	--	μV_{RMS}
Thermal Shutdown Temperature		T_{SD}		--	160	--	$^\circ C$
Thermal Shutdown Recovery Temperature				--	110	--	$^\circ C$

Note 1. Stresses listed as the above "Absolute Maximum Ratings" may cause permanent damage to the device. These are for stress ratings. Functional operation of the device at these or any other conditions beyond those indicated in the operational sections of the specifications is not implied. Exposure to absolute maximum rating conditions for extended periods may remain possibility to affect device reliability.

Note 2. Devices are ESD sensitive. Handling precaution is recommended.

Note 3. The device is not guaranteed to function outside its operating conditions.

Note 4. θ_{JA} is measured in the natural convection at $T_A = 25^\circ C$ on a low effective thermal conductivity test board of JEDEC 51-3 thermal measurement standard.

Typical Operating Characteristics

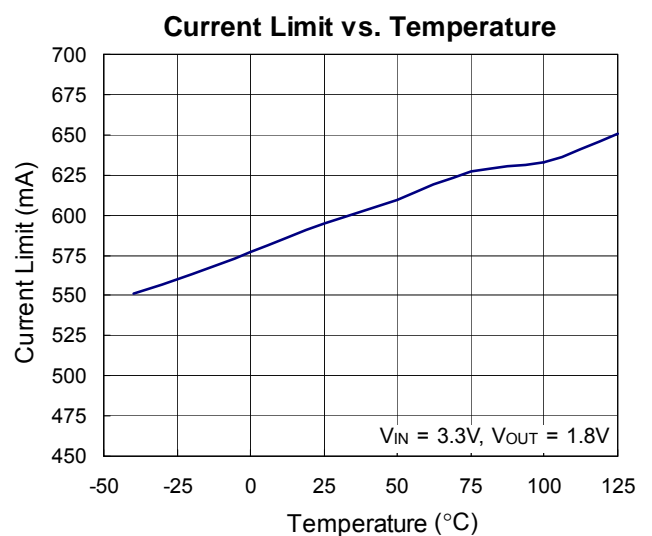
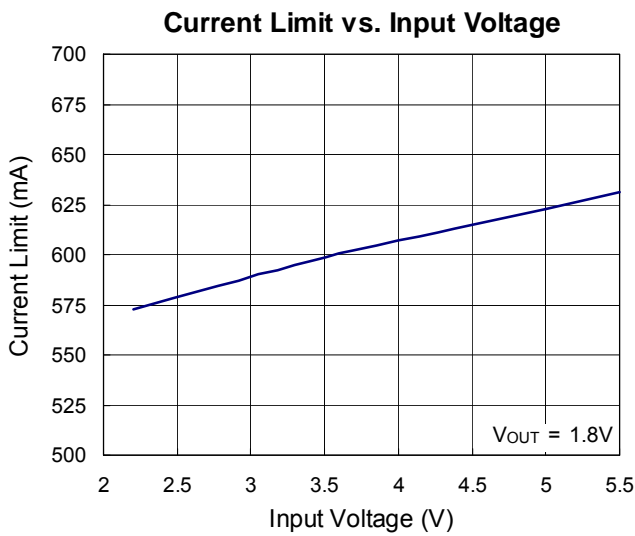
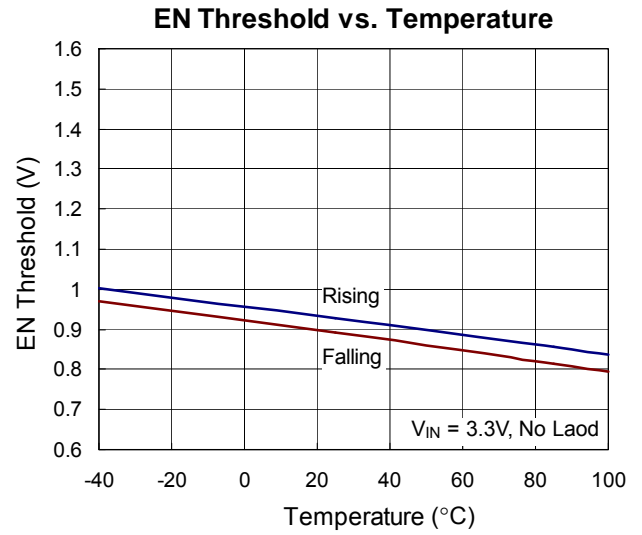
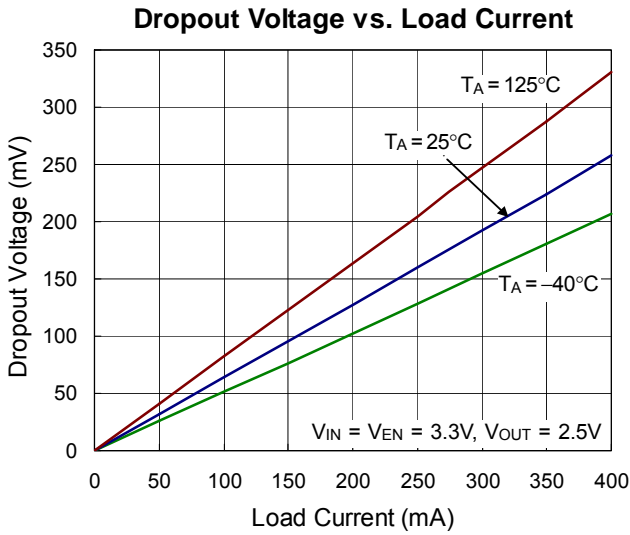
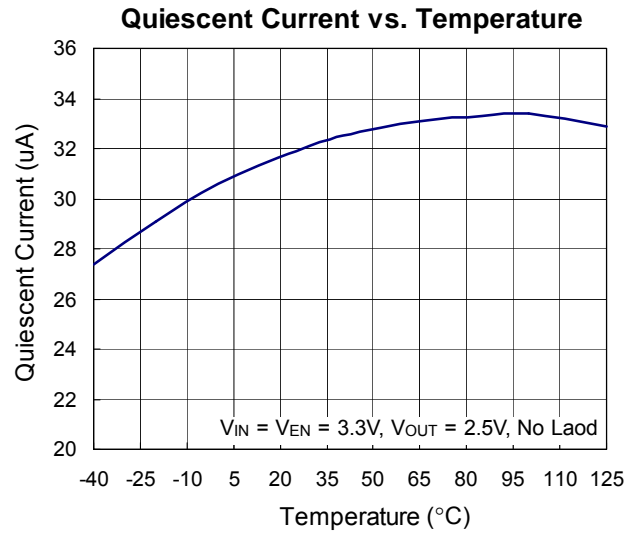
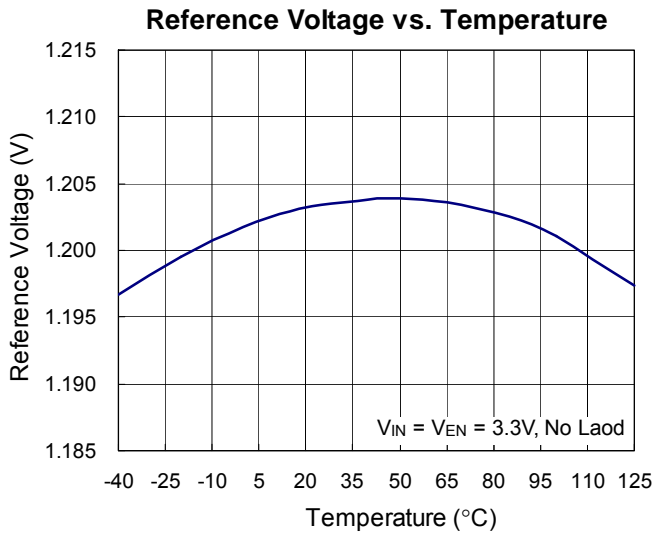

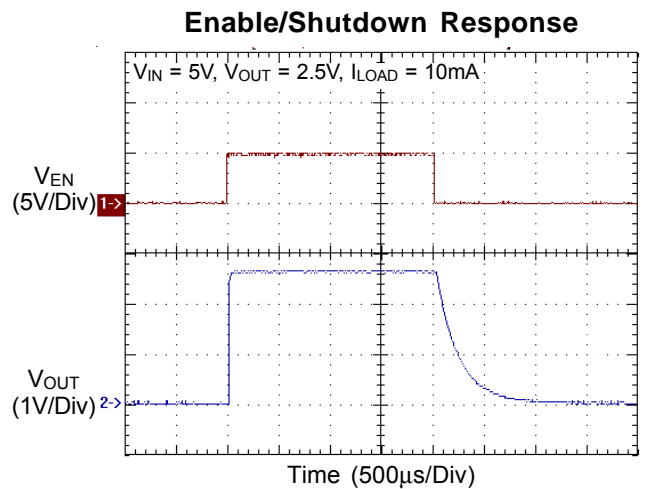
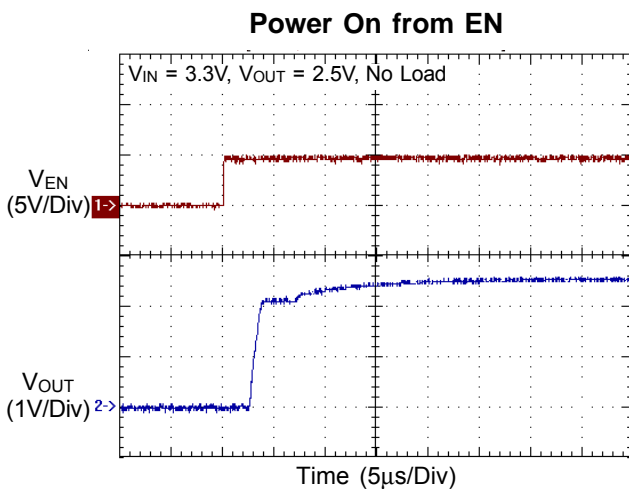
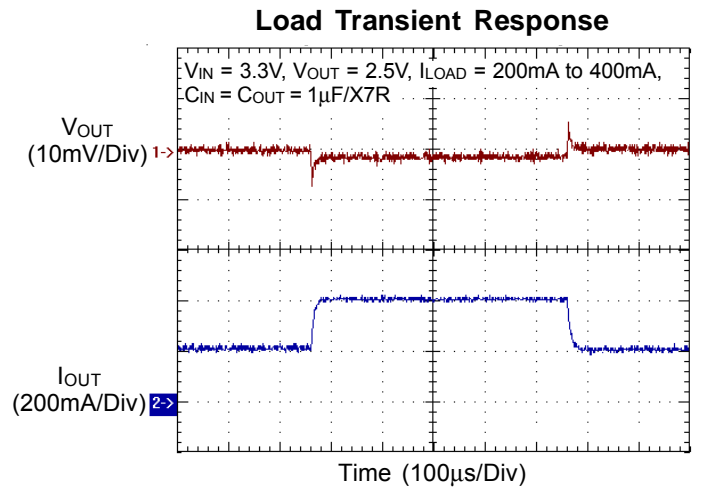
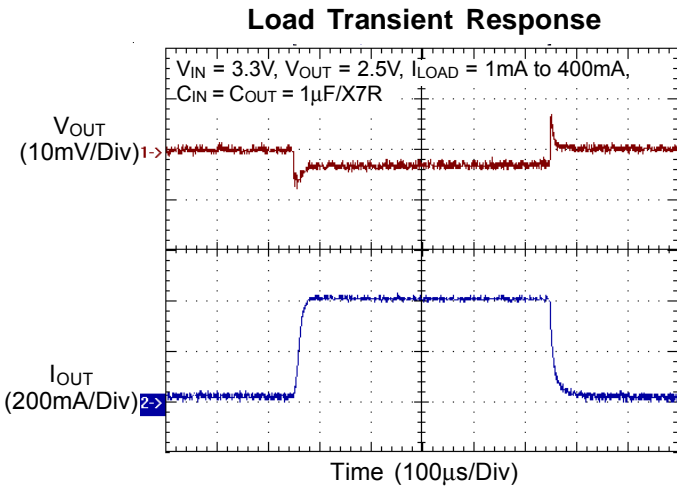
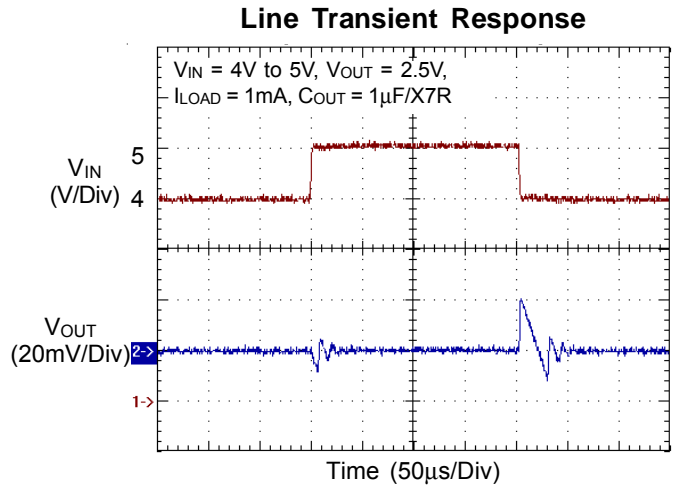
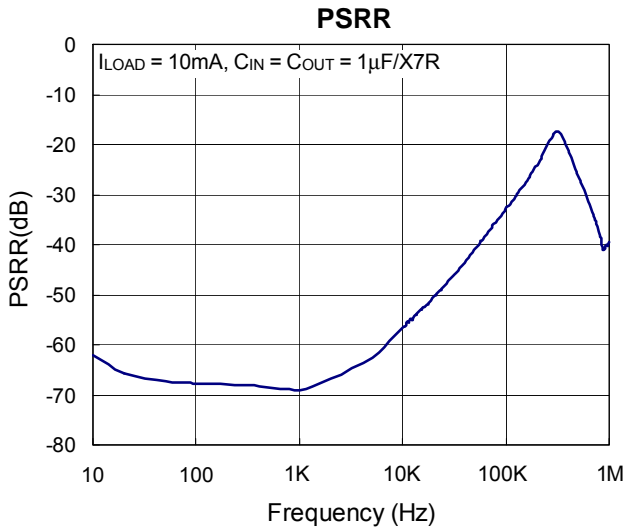

Application Information

Input Capacitor Selection

Like any low-dropout linear regulator, the external capacitors used with the RT9043 must be carefully selected for stability and performance. The input capacitance is recommended to be at least 1µF, and can be increased without limit. The input capacitor must be located at a distance of less than 0.5 inch from the input pin of the IC and returned to a clean ground plane. Any high-quality ceramic capacitor or tantalum capacitor can be used for the input capacitor. Using input capacitor with larger capacitance and lower ESR (equivalent series resistance) can obtain better PSRR and line transient response.

Output Capacitor Selection

The output capacitor must meet both the requirements for minimum capacitance and minimum ESR value in all applications. The RT9043 is designed specifically to work with low ESR ceramic output capacitor to save board space and have better performance. Figure 1 shows the allowable ESR range for stable operation as a function of load current and output capacitance value. Use at least 1µF ceramic output capacitor which ESR is within the stable operation range to ensure stability. Larger capacitance can reduce noise and improve load transient response, stability, and PSRR. The RT9043 can operate with other types of output capacitor due to its wide stable operation range. The output capacitor should be placed less than 0.5 inch from the V_{OUT} and returned to a clean ground plane.

Region of Stable C_{OUT} ESR vs. Load Current

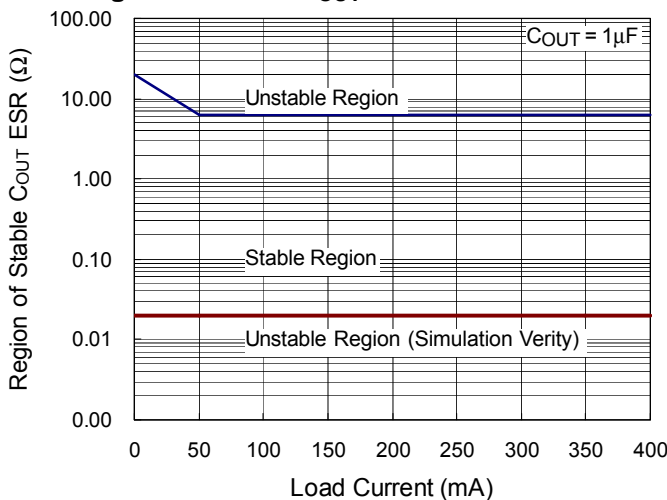

Figure 1

Output Voltage Setting

The output voltage divider R1 and R2 allows to adjust the output voltage for various application as shown in Figure 2.

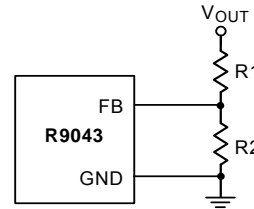

Figure 2. Output Voltage Setting

The output voltage is set according to the following equation:

$$V_{OUT} = V_{FB} \left(1 + \frac{R1}{R2} \right)$$

Where V_{FB} is the feedback reference voltage (1.2V typical).

Enable Function

The RT9043 features enable/shutdown function. The voltage at the EN pin determines the enable/shutdown state of the regulator. To ensure the regulator will switch on, the enable control voltage must be greater than 1.6V. The regulator will enter shutdown mode when the voltage at EN pin falls below 0.6 volt. If the enable function is not needed, EN pin should be pulled high or simply tied to V_{IN} to keep the regulator in on state.

PSRR

RT9043 features high power supply rejection ratio (PSRR), which is defined as the ratio of output voltage change against input voltage change.

$$PSRR = 20 \times \log \left(\frac{\Delta V_{OUT}}{\Delta V_{IN}} \right)$$

A low-dropout regulator with higher PSRR can provide better line transient performance.

Current Limit

The RT9043 implements an independent current limit circuit, which monitors and controls the pass element's gate voltage to limit the output current at 650mA (typ.). If the current limit condition lasts for a long time, the regulator temperature may increase high enough to damage the regulator itself. There fore, RT9043 implements current limit function and thermal protection function to prevent

the regulator from damaging when the output is shorted to ground.

Thermal Considerations

For continuous operation, do not exceed absolute maximum operation junction temperature. The maximum power dissipation depends on the thermal resistance of IC package, PCB layout, the rate of surroundings airflow and temperature difference between junction to ambient. The maximum power dissipation can be calculated by following formula :

$$P_{D(MAX)} = (T_{J(MAX)} - T_A) / \theta_{JA}$$

Where $T_{J(MAX)}$ is the maximum operation junction temperature, T_A is the ambient temperature and the θ_{JA} is the junction to ambient thermal resistance.

For recommended operating conditions specification of RT9043, the maximum junction temperature is 125°C. The junction to ambient thermal resistance θ_{JA} is layout dependent. For SOT-23-5 packages, the thermal resistance θ_{JA} is 250°C/W on the standard JEDEC 51-3 single layer thermal test board. The maximum power dissipation at $T_A = 25^\circ\text{C}$ can be calculated by following formula :

$$P_{D(MAX)} = (125^\circ\text{C} - 25^\circ\text{C}) / (250^\circ\text{C/W}) = 0.4\text{W for SOT-23-5 packages}$$

The maximum power dissipation depends on operating ambient temperature for fixed $T_{J(MAX)}$ and thermal resistance θ_{JA} . For RT9043 packages, the Figure 3 of derating curves allows the designer to see the effect of rising ambient temperature on the maximum power allowed.

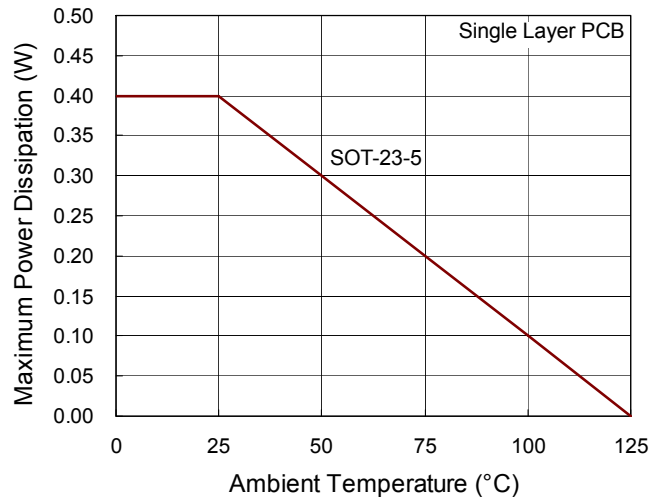
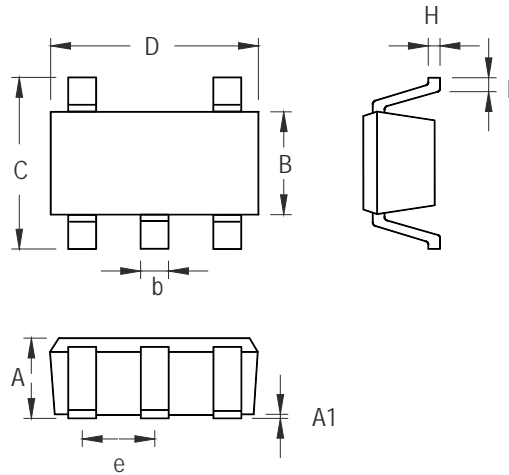

Figure 3. Derating Curves for RT9043 Packages

Outline Dimension



Symbol	Dimensions In Millimeters		Dimensions In Inches	
	Min	Max	Min	Max
A	0.889	1.295	0.035	0.051
A1	0.000	0.152	0.000	0.006
B	1.397	1.803	0.055	0.071
b	0.356	0.559	0.014	0.022
C	2.591	2.997	0.102	0.118
D	2.692	3.099	0.106	0.122
e	0.838	1.041	0.033	0.041
H	0.080	0.254	0.003	0.010
L	0.300	0.610	0.012	0.024

SOT-23-5 Surface Mount Package

Richtek Technology Corporation

Headquarter
 5F, No. 20, Taiyuen Street, Chupei City
 Hsinchu, Taiwan, R.O.C.
 Tel: (8863)5526789 Fax: (8863)5526611

Richtek Technology Corporation

Taipei Office (Marketing)
 8F, No. 137, Lane 235, Paochiao Road, Hsintien City
 Taipei County, Taiwan, R.O.C.
 Tel: (8862)89191466 Fax: (8862)89191465
 Email: marketing@richtek.com

Information that is provided by Richtek Technology Corporation is believed to be accurate and reliable. Richtek reserves the right to make any change in circuit design, specification or other related things if necessary without notice at any time. No third party intellectual property infringement of the applications should be guaranteed by users when integrating Richtek products into any application. No legal responsibility for any said applications is assumed by Richtek.