

AL Series

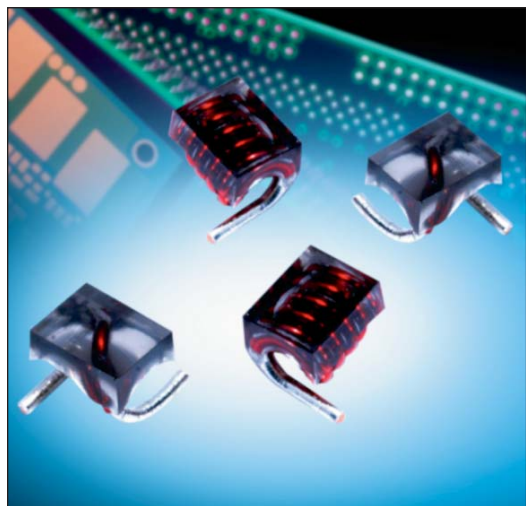

GENERAL DESCRIPTION

AVX Air Core RF Inductors, part of the wound air core inductor family, are ideal for RF circuits, broadband I/O filtering, frequency selection, or impedance matching. The air core inductor provides better performance over solid core inductors with higher Q, and better current handling capabilities.

FEATURES

- Air Core Construction
- High Q
- High Current
- Excellent SRF
- Many inductance values ranging from 1.65nH to 538nH

APPLICATIONS

- RF Applications
- RF Circuits
- Broadband I/O Filtering
- Impedance Matching/Tuning
- Decoupling/Bypassing

HOW TO ORDER

AL ┆	05A ┆	02N5 ┆	G ┆	T ┆	R ┆
Air Core Inductor	Size	Inductance	Tolerance	Termination	Packaging
	Size	02N5 = 2.5nH 12N5 = 12.5nH 130N = 130nH	G = 2% J = 5% K = 10%	T = Sn/Ag over Cu (96.5% Sn, 3% Ag, 0.5% Cu)	R = 7" reel S = 13" reel*
	05A = 0605 05B = 0605 12A = 1212 12B = 1212 016 = 1516 023 = 2523				*AL016 & AL023 Only

ELECTRICAL SPECIFICATIONS

Technical Data	All technical data related to an ambient temperature of +25°C
Inductance Range	1.65nH to 538nH
Inductance Tolerance	2%, 5%, 10%
Rated Current	1.5A to 4.0A
Operating Temperature	-40°C to +125°C
Termination	96.5% Tin/3% Silver over 0.5% Copper

Air Core RF Inductors



AL Series

ELECTRICAL SPECIFICATIONS

AVX P/N	Turns	Inductance (nH)	Tolerance (%)	Q min.	Q typ.	Test Freq. (MHz)	DCR max (mΩ)	SRF GHz (min.)	Ir max Amps
AL05A1N65KTR	2	1.65	K	100	-	800	4	10	1.60
AL05A2N55*TR	3	2.55	J, K	100	-	800	5	8.2	1.60
AL05A3N85*TR	4	3.85	G, J, K	100	-	800	6	7.5	1.60
AL05A5N45*TR	5	5.45	G, J	100	-	800	8	7	1.60
AL05B05N6*TR	6	5.6	G, J	100	-	800	9	6.5	1.60
AL05B7N15*TR	7	7.15	G, J	100	-	800	10	6	1.60
AL05B08N8*TR	8	8.8	G, J	100	-	800	12	6	1.60
AL05B9N85*TR	9	9.85	G, J	100	-	800	13	5.2	1.60
AL05B12N5*TR	10	12.55	G, J	100	-	800	14	4.6	1.60
AL12A02N5KTR	1	2.5	K	145	-	150	1.1	12.5	4.00
AL12A05N0*TR	2	5	J, K	140	-	150	1.8	6.5	4.00
AL12A08N0*TR	3	8	G, J	140	-	150	2.6	5	4.00
AL12A12N5*TR	4	12.5	G, J	137	-	150	3.4	3.3	4.00
AL12A18N5*TR	5	18.5	G, J	132	-	150	3.9	2.5	4.00
AL12B17N5*TR	6	17.5	G, J	100	-	150	4.5	2.2	4.00
AL12B22N0*TR	7	22	G, J	102	-	150	5.2	2.1	4.00
AL12B28N0*TR	8	28	G, J	105	-	150	6	1.8	4.00
AL12B33N5*TR	9	35.5	G, J	112	-	150	6.8	1.5	4.00
AL12B43N0*TR	10	43	G, J	106	-	150	7.9	1.2	4.00
AL01622N0*TS	4	22	G, J	100	135	150	4.2	3.2	3.00
AL01627N0*TS	5	27	G, J	100	135	150	4	2.7	3.50
AL01633N0*TS	5	33	G, J	100	130	150	4.8	2.5	3.00
AL01639N0*TS	6	39	G, J	100	135	150	4.4	2.1	3.00
AL01647N0*TS	6	47	G, J	100	135	150	5.6	2.1	3.00
AL01656N0*TS	7	56	G, J	100	125	150	6.2	1.5	3.00
AL01668N0*TS	7	68	G, J	100	120	150	8.2	1.5	2.50
AL01682N0*TS	8	82	G, J	100	120	150	9.4	1.3	2.50
AL016100N*TS	9	100	G, J	100	115	150	12.3	1.2	1.70
AL016120N*TS	9	120	G, J	100	125	150	17.3	1.1	1.50
AL02390N0*TS	9	90	G, J	95	114	50	15	1.140	3.50
AL023111N*TS	10	111	G, J	87	104	50	15	1.020	3.50
AL023130N*TS	11	130	G, J	87	104	50	20	0.900	3.00
AL023169N*TS	12	169	G, J	95	114	50	25	0.875	3.00
AL023206N*TS	13	206	G, J	95	114	50	30	0.800	3.00
AL023222N*TS	14	222	G, J	92	110	50	35	0.730	3.00
AL023246N*TS	15	246	G, J	95	114	50	35	0.685	3.00
AL023307N*TS	16	307	G, J	95	114	50	35	0.660	3.00
AL023380N*TS	17	380	G, J	95	114	50	50	0.590	2.50
AL023422N*TS	18	422	G, J	95	114	50	60	0.540	2.50
AL023491N*TS	19	491	G, J	95	114	50	65	0.535	2.00
AL023538N*TS	20	538	G, J	87	104	50	90	0.490	2.00

*Tolerance: G= ± 2%, J: ± 5%, K: ± 10%

a. Test Equipment:

L/Q: HP-4291B With HP16193A test fixture or equivalent.

SRF: HP8753E /HP8720D or equivalent.

RDC: Chroma 16502 or equivalent.

b. Operating temperature range: -40°C to +125°C.

c. For Temperature Rise: 15°C

d. Storage Temp.: -40°C to +85°C.

f. MSL: Level 1

PHYSICAL DIMENSIONS

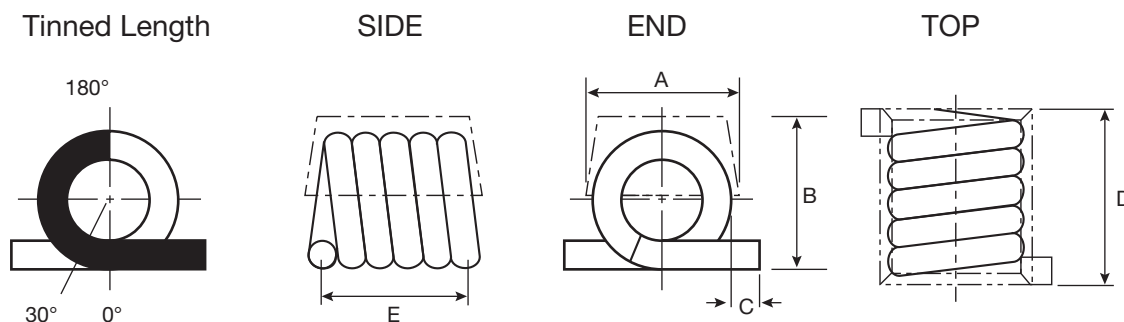

mm (inches)

Part Number	A	B	C	D	E
AL05A	1.42 ± 0.13 (0.056 ± 0.005)	1.37 ± 0.15 (0.056 ± 0.005)	0.89 ± 0.25 (0.035 ± 0.010)	2.21 ± 0.25 (0.087 ± 0.010)	1.83 ± 0.25 (0.072 ± 0.010)
AL05B	1.42 ± 0.13 (0.056 ± 0.005)	1.37 ± 0.15 (0.056 ± 0.005)	0.89 ± 0.25 (0.035 ± 0.010)	4.04 ± 0.30 (0.159 ± 0.012)	3.66 ± 0.30 (0.144 ± 0.012)
AL12A	3.05 max. (0.120 max.)	3.18 max. (0.125 max.)	0.58 ± 0.38 (0.023 ± .0015)	3.68 max. (0.145 max.)	2.92 ± 0.25 (0.115 ± 0.010)
AL12B	3.05 max. (0.120 max.)	3.18 max. (0.125 max.)	0.58 ± 0.38 (0.023 ± 0.015)	6.86 max. (0.270 max.)	5.84 ± 0.25 (0.230 ± 0.010)
AL016	3.81 (0.150)	4.20 max. (0.165 max.)	1.53 ± 0.39 (0.060 ± 0.015)	4.83 max. (0.190 max.)	4.32 ± 0.39 (0.170 ± 0.015)
AL023	6.35 max. (0.250 max.)	5.90 max. (0.232 max.)	1.02 ± 0.39 (0.040 ± 0.015)	10.55 max. (0.415 max.)	7.98 ± 0.51 (0.314 ± 0.020)

RECOMMENDED LAND PATTERNS

mm (inches)

Part Number	A	B	C	D	E
AL05A	2.62 (0.103)	2.46 (0.097)	1.04 (0.041)	1.02 (0.040)	0.79 (0.031)
AL05B	4.45 (0.175)	2.46 (0.097)	2.87 (0.113)	1.02 (0.040)	0.79 (0.031)
AL12A	4.19 (0.165)	3.30 (0.130)	1.65 (0.065)	2.79 (0.110)	1.27 (0.050)
AL12B	7.24 (0.285)	3.30 (0.130)	4.70 (0.185)	2.79 (0.110)	1.27 (0.050)
AL016	5.80 (0.228)	5.16 (0.203)	2.85 (0.112)	2.62 (0.103)	1.48 (0.058)
AL023	10.0 (0.394)	4.70 (0.185)	5.95 (0.234)	2.42 (0.095)	2.04 (0.080)

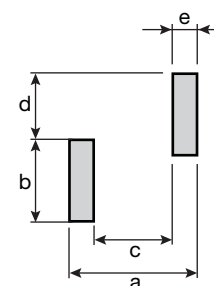

PERFORMANCE SPECIFICATIONS

AL05A

Inductance vs. Frequency

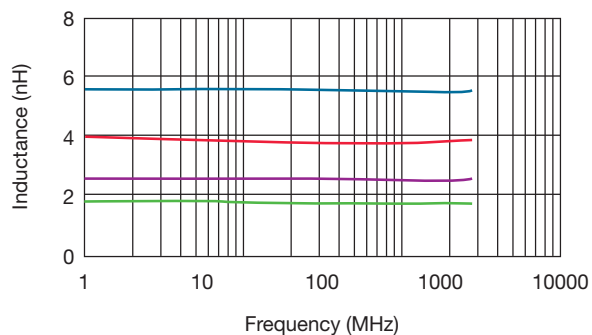

Typical Q vs. Frequency

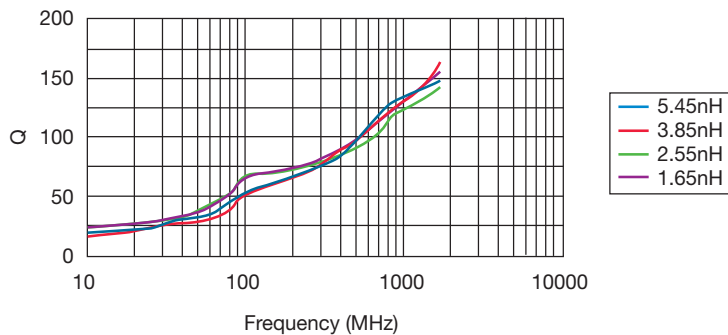

AL05B

Inductance vs. Frequency

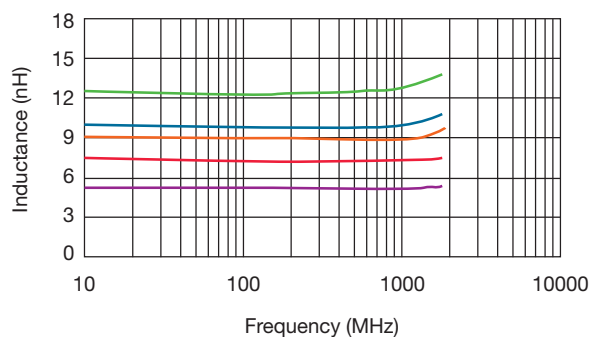

Typical Q vs. Frequency

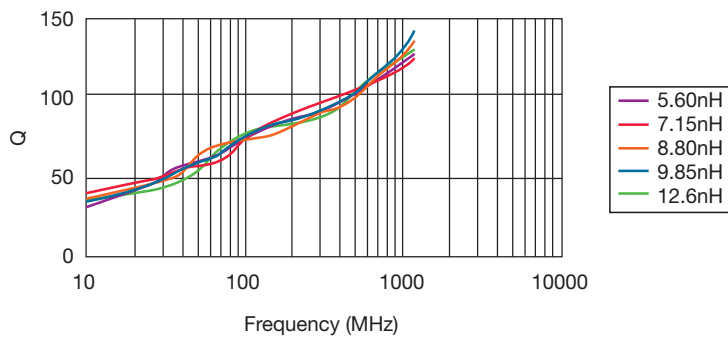

AL12A

Inductance vs. Frequency

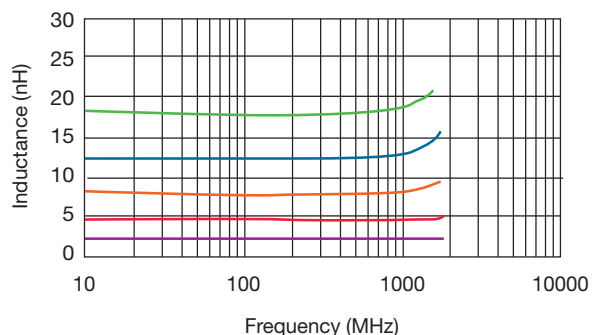

Typical Q vs. Frequency

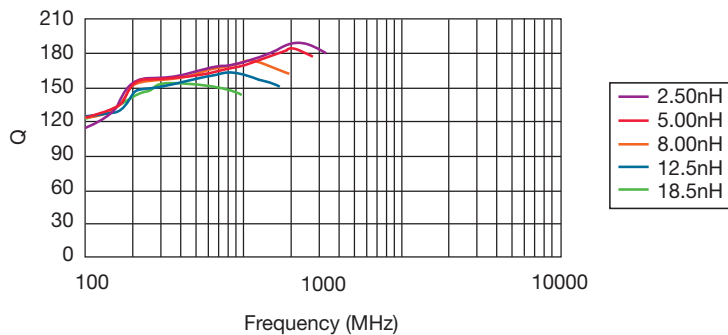

PERFORMANCE SPECIFICATIONS

AL12B

Inductance vs. Frequency

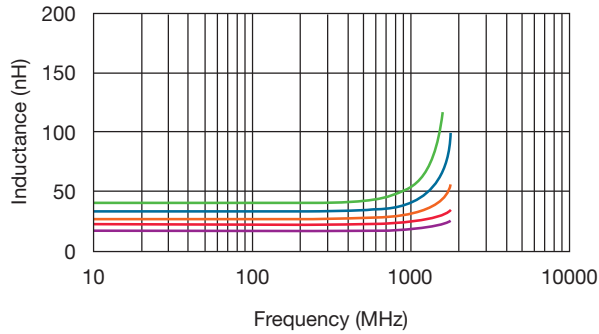

Typical Q vs. Frequency

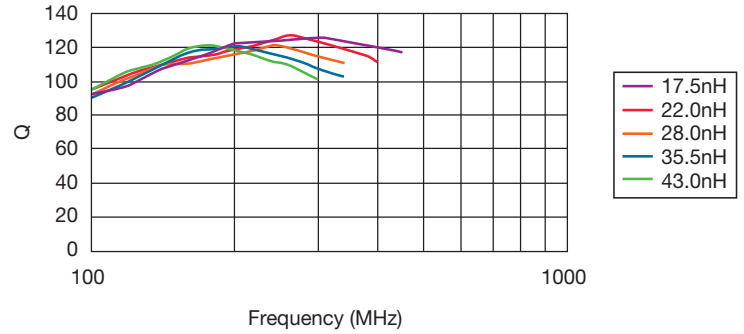

AL016

Inductance vs. Frequency

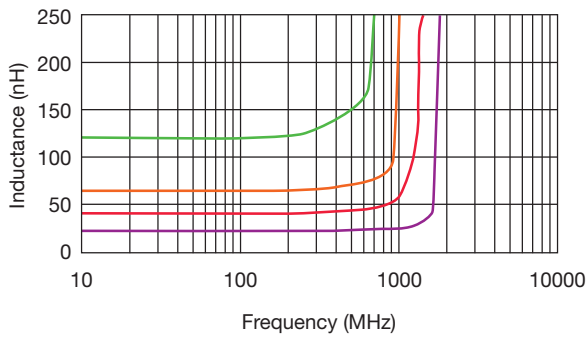

Typical Q vs. Frequency

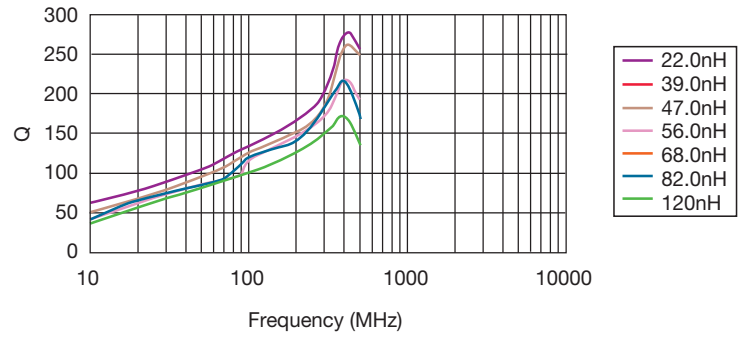

AL023

Inductance vs. Frequency

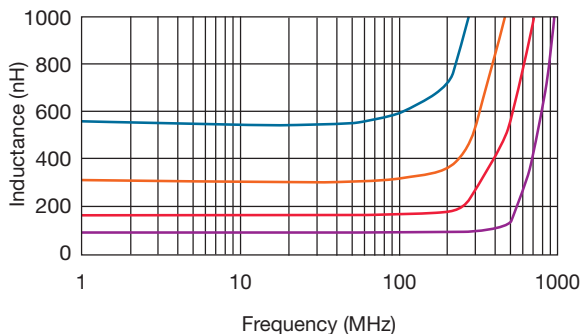

Typical Q vs. Frequency

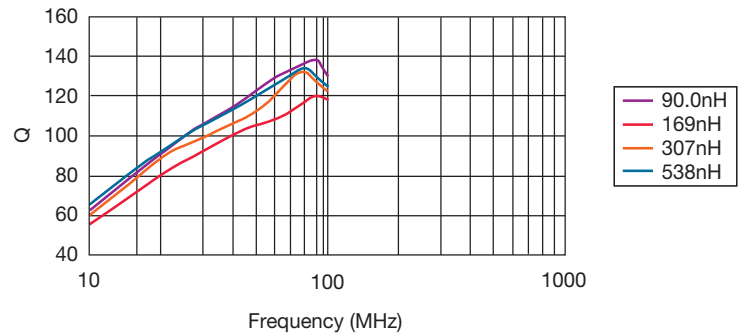

TYPICAL RoHS REFLOW PROFILE

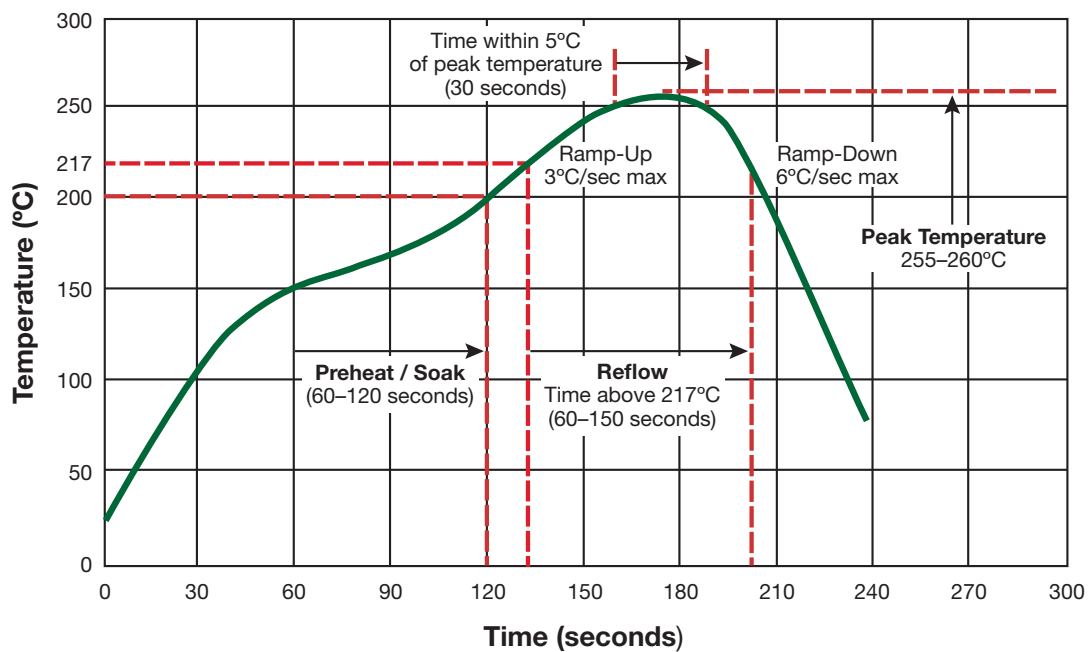

PACKAGING SPECIFICATIONS

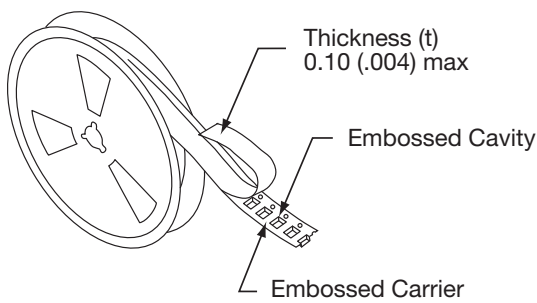

- The force for tearing off cover tape is 10 to 130 grams in the arrow direction

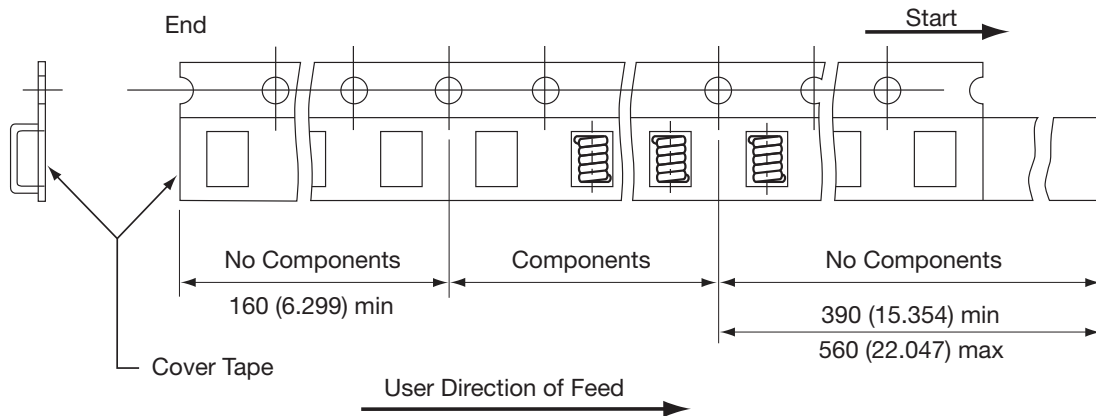
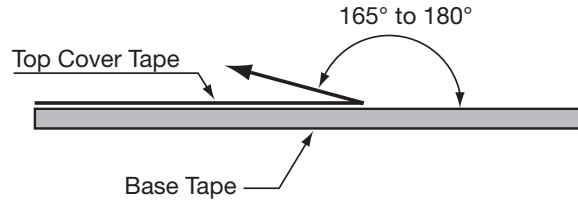

CARRIER TAPE REELS

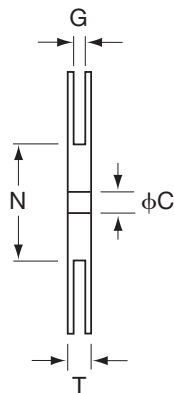
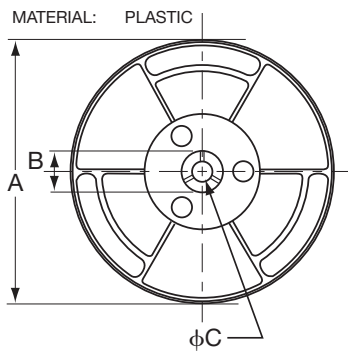

DIMENSIONS OF CARRIER TAPE

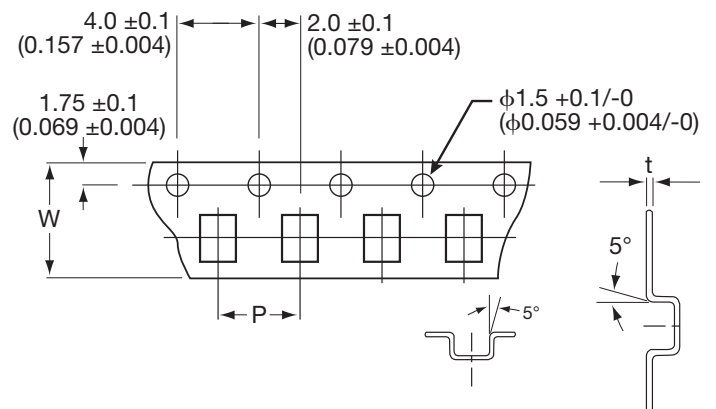

mm (inches)

Series	ITEM	A	B	C	N	G	T	W	P	t
AL05A	DIM.	178	21	13	75	8.4	12.5	8	4	0.30
	TOL.	± 2.0	± 0.8	± 0.8	± 2.0	+1.5	+1.5	± 0.3	± 0.1	± 0.05
AL05B	DIM.	180	21	13	50	12.4	18.4	12	4	0.35
	TOL.	MAX	± 0.8	+0.5/-0.2	MIN	+2.0	MAX	± 0.30	± 0.10	± 0.05
AL12A	DIM.	178	25	15	75	12.5	16.4	12	8	0.25
	TOL.	± 2.0	± 1.0	± 0.5	± 2.0	+1.5	+1.5	± 0.2	± 0.1	± 0.05
AL12B	DIM.	178	50	15	75	16.5	20.4	16	8	0.25
	TOL.	± 2.0	± 1.0	± 0.5	± 2.0	+1.5	+1.5	± 0.2	± 0.1	± 0.05
AL016	DIM.	340	20.2	13	100	16.5	25.5	16	12	0.30
	TOL.	MAX	MIN	± 0.5	REF	± 0.5	± 0.5	± 0.30	± 0.10	± 0.05
AL023	DIM.	340	20.2	13	100	24.5	30.4	24.0	12.0	0.35
	TOL.	MAX	MIN	± 0.5	REF	± 0.5	± 0.5	± 0.30	± 0.10	± 0.05