

General Description

The AO8801A uses advanced trench technology to provide excellent $R_{DS(ON)}$, low gate charge and operation with gate voltages as low as 1.8V. This device is suitable for use as a load switch or in PWM applications.

Product Summary

V_{DS}	-20V
I_D (at $V_{GS}=-10V$)	-4.5A
$R_{DS(ON)}$ (at $V_{GS}=-4.5V$)	< 42m Ω
$R_{DS(ON)}$ (at $V_{GS}=-2.5V$)	< 54m Ω
$R_{DS(ON)}$ (at $V_{GS}=-1.8V$)	< 68m Ω

ESD Protected

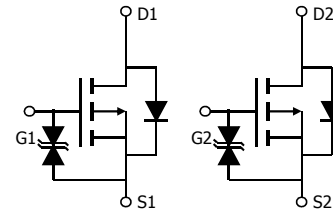
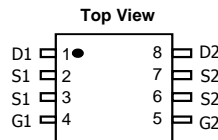
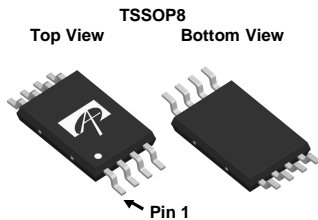

Absolute Maximum Ratings $T_A=25^\circ\text{C}$ unless otherwise noted

Parameter	Symbol	Maximum	Units
Drain-Source Voltage	V_{DS}	-20	V
Gate-Source Voltage	V_{GS}	± 8	V
Continuous Drain Current	I_D	$T_A=25^\circ\text{C}$	-4.5
		$T_A=70^\circ\text{C}$	-3.6
Pulsed Drain Current ^C	I_{DM}	-30	A
Power Dissipation ^B	P_D	$T_A=25^\circ\text{C}$	1.5
		$T_A=70^\circ\text{C}$	0.96
Junction and Storage Temperature Range	T_J, T_{STG}	-55 to 150	$^\circ\text{C}$

Thermal Characteristics

Parameter	Symbol	Typ	Max	Units
Maximum Junction-to-Ambient ^A	$R_{\theta JA}$	63	83	$^\circ\text{C}/\text{W}$
Maximum Junction-to-Ambient ^{A,D}		Steady-State	101	130
Maximum Junction-to-Lead	$R_{\theta JL}$	64	83	$^\circ\text{C}/\text{W}$

Electrical Characteristics (T_J=25°C unless otherwise noted)

Symbol	Parameter	Conditions	Min	Typ	Max	Units
STATIC PARAMETERS						
BV _{DSS}	Drain-Source Breakdown Voltage	I _D =-250μA, V _{GS} =0V	-20			V
I _{DSS}	Zero Gate Voltage Drain Current	V _{DS} =-20V, V _{GS} =0V T _J =55°C			-1 -5	μA
I _{GSS}	Gate-Body leakage current	V _{DS} =0V, V _{GS} = ±8V			±10	μA
V _{GS(th)}	Gate Threshold Voltage	V _{DS} =V _{GS} , I _D =-250μA	-0.3	-0.57	-0.9	V
I _{D(ON)}	On state drain current	V _{GS} =-4.5V, V _{DS} =-5V	-30			A
R _{DS(ON)}	Static Drain-Source On-Resistance	V _{GS} =-4.5V, I _D =-4.5A T _J =125°C		35 49	42 59	mΩ
		V _{GS} =-2.5V, I _D =-4A		43	54	
		V _{GS} =-1.8V, I _D =-3A		54	68	
g _{FS}	Forward Transconductance	V _{DS} =-5V, I _D =-4.5A		20		S
V _{SD}	Diode Forward Voltage	I _S =-1A, V _{GS} =0V		-0.64	-1	V
I _S	Maximum Body-Diode Continuous Current				-2	A
DYNAMIC PARAMETERS						
C _{iss}	Input Capacitance	V _{GS} =0V, V _{DS} =-10V, f=1MHz	600	751	905	pF
C _{oss}	Output Capacitance		80	115	150	pF
C _{rss}	Reverse Transfer Capacitance		48	80	115	pF
R _g	Gate resistance	V _{GS} =0V, V _{DS} =0V, f=1MHz	6	13	20	Ω
SWITCHING PARAMETERS						
Q _g	Total Gate Charge	V _{GS} =-4.5V, V _{DS} =-10V, I _D =-4.5A	7.4	9.3	11	nC
Q _{gs}	Gate Source Charge		0.8	1	1.2	nC
Q _{gd}	Gate Drain Charge		1.3	2.2	3.1	nC
t _{D(on)}	Turn-On DelayTime	V _{GS} =-4.5V, V _{DS} =-10V, R _L =2.2Ω, R _{GEN} =3Ω		13		ns
t _r	Turn-On Rise Time			9		ns
t _{D(off)}	Turn-Off DelayTime			19		ns
t _f	Turn-Off Fall Time			29		ns
t _{rr}	Body Diode Reverse Recovery Time	I _F =-4.5A, dI/dt=500A/μs	20	26	32	ns
Q _{rr}	Body Diode Reverse Recovery Charge	I _F =-4.5A, dI/dt=500A/μs	40	51	62	nC

A. The value of R_{θJA} is measured with the device mounted on 1in² FR-4 board with 2oz. Copper, in a still air environment with T_A=25° C. The value in any given application depends on the user's specific board design.

B. The power dissipation P_D is based on T_{J(MAX)}=150° C, using ≤ 10s junction-to-ambient thermal resistance.

C. Repetitive rating, pulse width limited by junction temperature T_{J(MAX)}=150° C. Ratings are based on low frequency and duty cycles to keep initial T_J=25° C.

D. The R_{θJA} is the sum of the thermal impedance from junction to lead R_{θJL} and lead to ambient.

E. The static characteristics in Figures 1 to 6 are obtained using <300μs pulses, duty cycle 0.5% max.

F. These curves are based on the junction-to-ambient thermal impedance which is measured with the device mounted on 1in² FR-4 board with 2oz. Copper, assuming a maximum junction temperature of T_{J(MAX)}=150° C. The SOA curve provides a single pulse rating.

COMPONENTS IN LIFE SUPPORT DEVICES OR SYSTEMS ARE NOT AUTHORIZED. AOS DOES NOT ASSUME ANY LIABILITY ARISING OUT OF SUCH APPLICATIONS OR USES OF ITS PRODUCTS. AOS RESERVES THE RIGHT TO IMPROVE PRODUCT DESIGN, FUNCTIONS AND RELIABILITY WITHOUT NOTICE.

TYPICAL ELECTRICAL AND THERMAL CHARACTERISTICS

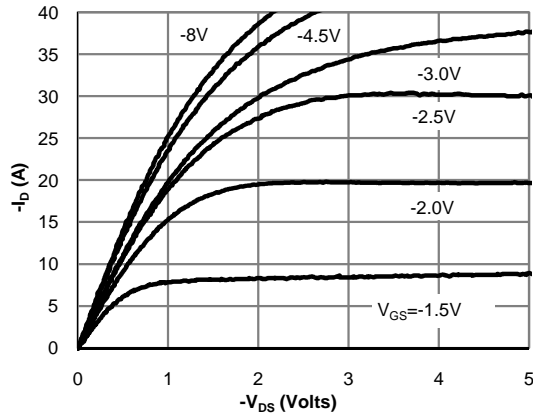

Figure 1: On-Region Characteristics (Note E)

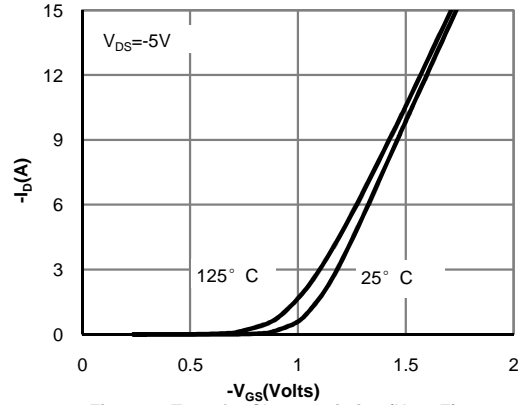

Figure 2: Transfer Characteristics (Note E)

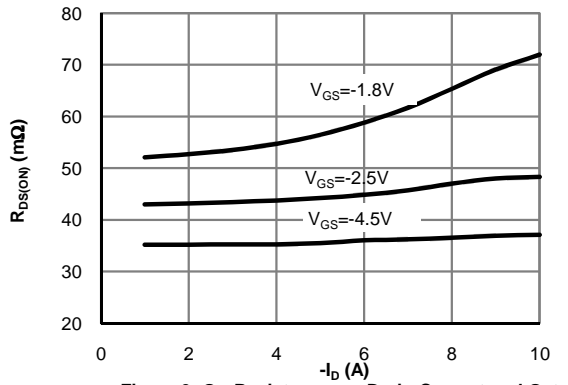

Figure 3: On-Resistance vs. Drain Current and Gate Voltage (Note E)

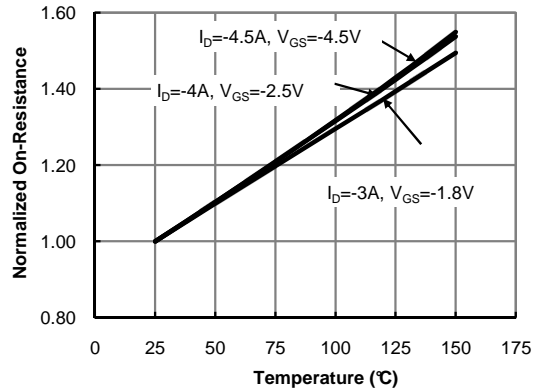

Figure 4: On-Resistance vs. Junction Temperature (Note E)

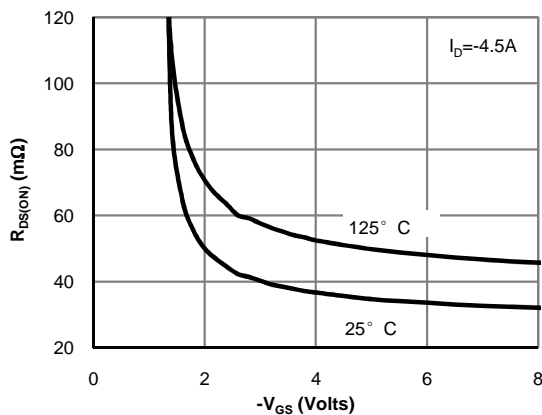

Figure 5: On-Resistance vs. Gate-Source Voltage (Note E)

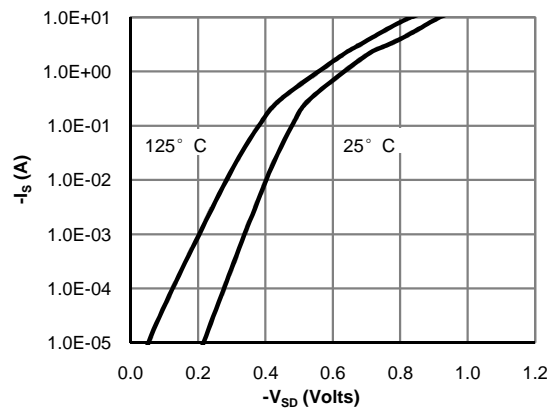

Figure 6: Body-Diode Characteristics (Note E)

TYPICAL ELECTRICAL AND THERMAL CHARACTERISTICS

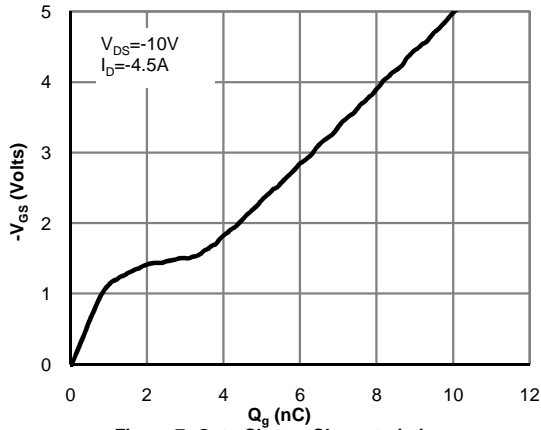

Figure 7: Gate-Charge Characteristics

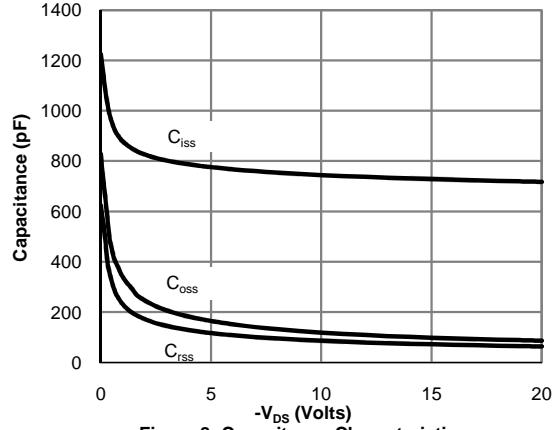

Figure 8: Capacitance Characteristics

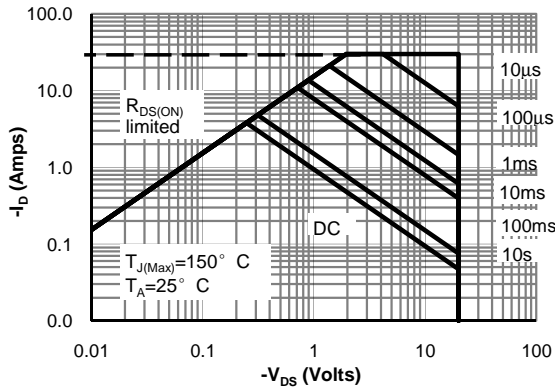

Figure 9: Maximum Forward Biased Safe Operating Area (Note F)

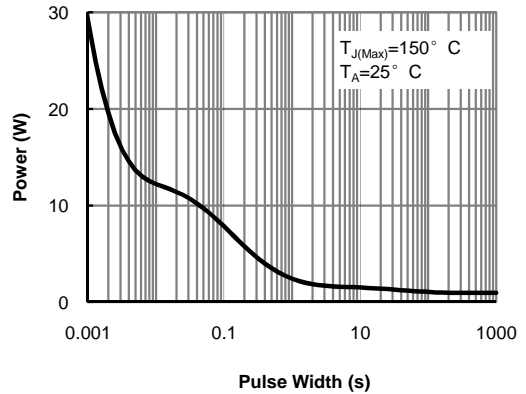

Figure 10: Single Pulse Power Rating Junction-to-Ambient (Note F)

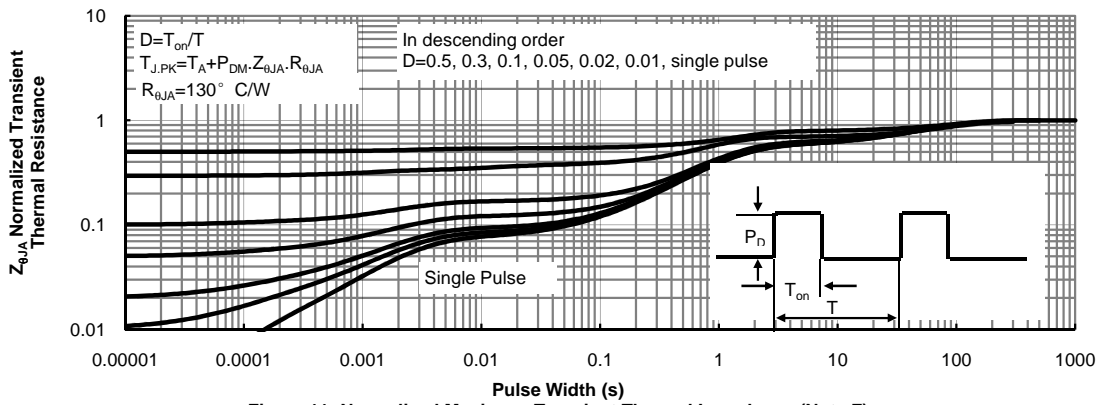
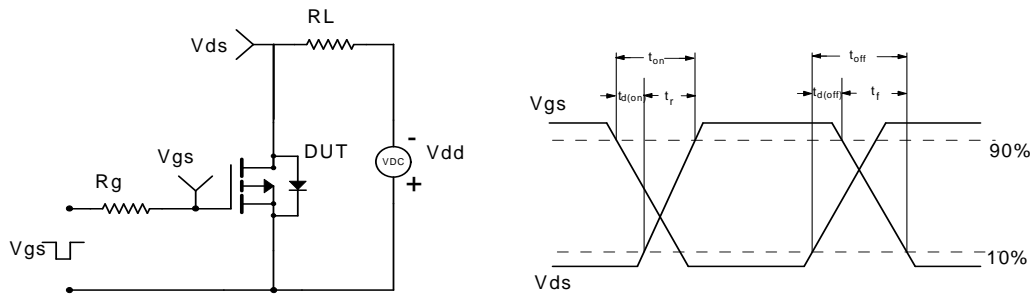

Figure 11: Normalized Maximum Transient Thermal Impedance (Note F)

Gate Charge Test Circuit & Waveform



Resistive Switching Test Circuit & Waveforms



Diode Recovery Test Circuit & Waveforms

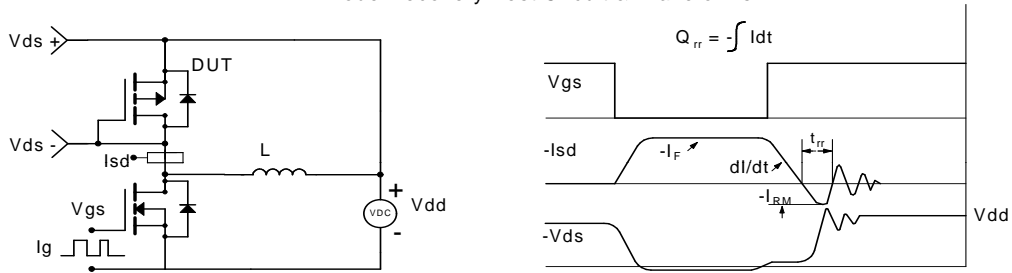



Document No.	PD-01079
Version	B
Title	AO8801A Marking Description

TSSOP-8 PACKAGE MARKING DESCRIPTION

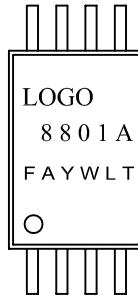

Green product

NOTE:
LOGO - AOS Logo
8801A - Part number code
F&A - Fab and Assembly location code
Y - Year code
W - Week code
L&T - Assembly lot code

PART NO.	DESCRIPTION	CODE
AO8801A	Green product	8801A
AO8801AL	Green product	8801A



TSSOP8 PACKAGE OUTLINE

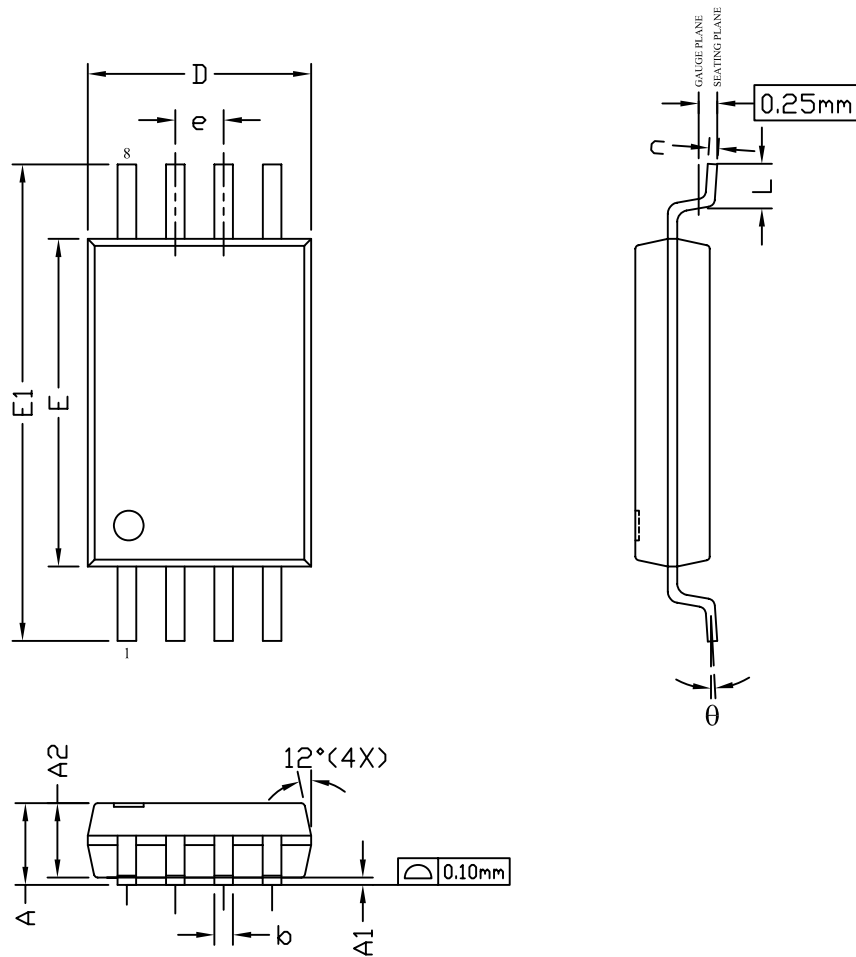

RECOMMENDED LAND PATTERN

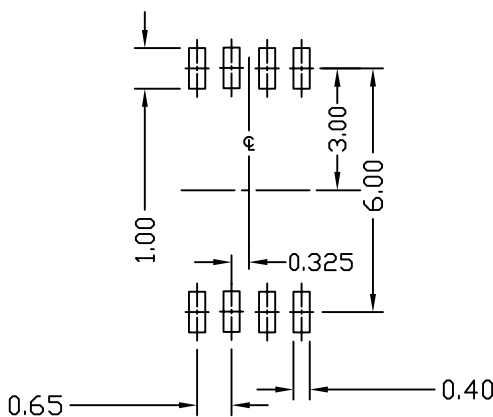

SYMBOLS	DIMENSIONS IN MILLIMETERS			DIMENSIONS IN INCHES		
	MIN	NOM	MAX	MIN	NOM	MAX
A	—	—	1.20	—	—	0.047
A1	0.05	—	0.15	0.002	—	0.006
A2	0.80	1.00	1.05	0.031	0.039	0.041
b	0.19	—	0.30	0.007	—	0.012
c	0.09	—	0.20	0.004	—	0.008
D	2.90	3.00	3.10	0.114	0.118	0.122
E1	6.40 BSC			0.252 BSC		
E	4.30	4.40	4.50	0.169	0.173	0.177
e	0.65 BSC			0.026 BSC		
L	0.45	0.60	0.75	0.018	0.024	0.030
θ	0°	—	8°	0°	—	8°

UNIT: mm

NOTE

1. ALL DIMENSIONS ARE IN MILLIMETERS.
2. DIMENSIONS ARE INCLUSIVE OF PLATING.
3. PACKAGE BODY SIZES EXCLUDE MOLD FLASH AND GATE BURRS.
MOLD FLASH AT THE NON-LEAD SIDES SHOULD BE LESS THAN 6 MILS EACH.
4. DIMENSION L IS MEASURED IN GAUGE PLANE.
5. CONTROLLING DIMENSION IS MILLIMETER.
CONVERTED INCH DIMENSIONS ARE NOT NECESSARILY EXACT.
6. REFER TO JEDEC MO-153(AA)



TSSOP-8 Carrier Tape

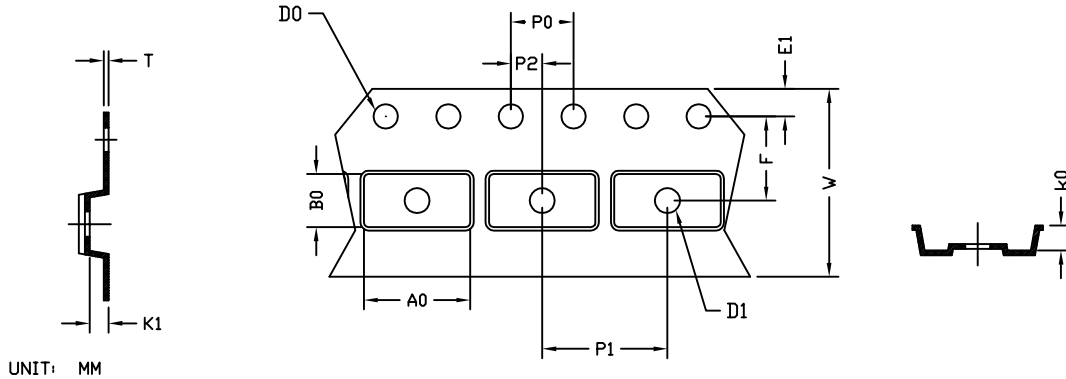

UNIT: MM

PACKAGE	A0	B0	K0	K1	D0	D1	W	E1	F	P0	P1	P2	T
TSSOP8 (12 mm)	6.90 ±0.10	3.50 ±0.10	1.60 ±0.10	1.20 ±0.10	1.55 ±0.05	1.60 ±0.10	12.00 ±0.30	1.75 ±0.10	5.50 ±0.05	4.00 ±0.10	8.00 ±0.10	2.00 ±0.05	0.30 ±0.05

TSSOP-8 Reel

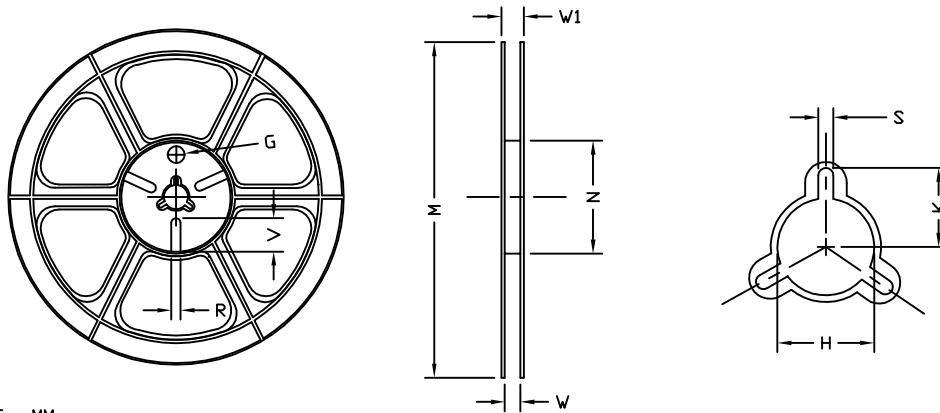

UNIT: MM

TAPE SIZE	REEL SIZE	M	N	W	W1	H	K	S	G	R	V
12 mm	ø330	ø330.00 ±0.50	ø97.00 ±0.10	13.00 ±0.30	17.40 ±1.00	ø13.00 +0.50 -0.20	10.60	2.00 ±0.50	---	---	---

TSSOP-8 Tape

Leader / Trailer
& Orientation

Unit Per Reel:
3000pcs

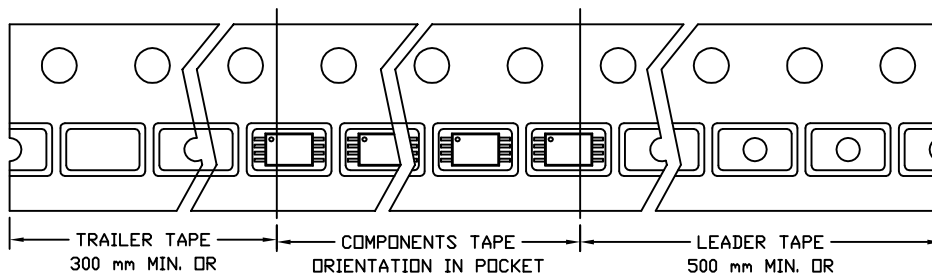



AOS Semiconductor Product Reliability Report

AO8801A, rev B

Plastic Encapsulated Device

ALPHA & OMEGA Semiconductor, Inc

www.aosmd.com

Sep, 2018

This AOS product reliability report summarizes the qualification result for AO8801A. Accelerated environmental tests are performed on a specific sample size, and then followed by electrical test at end point. Review of final electrical test result confirms that AO8801A passes AOS quality and reliability requirements. The released product will be categorized by the process family and be routine monitored for continuously improving the product quality.

I. Reliability Stress Test Summary and Results

Test Item	Test Condition	Time Point	Total Sample Size	Number of Failures	Reference Standard
HTGB	Temp = 150°C , Vgs=100% of Vgsmax	168 / 500 / 1000 hours	924 pcs	0	JESD22-A108
HTRB	Temp = 150°C , Vds=80% of Vdsmax	168 / 500 / 1000 hours	924 pcs	0	JESD22-A108
Precondition (Note A)	168hr 85°C / 85%RH + 3 cycle reflow @260°C (MSL 1)	-	4620 pcs	0	JESD22-A113
HAST	130°C , 85%RH, 33.3 psia, Vds = 80% of Vdsmax	96 hours	693 pcs	0	JESD22-A110
H3TRB	85°C , 85%RH, Vds = 80% of Vdsmax	1000 hours	693 pcs	0	JESD22-A101
Autoclave	121°C , 29.7psia, RH=100%	96 hours	924 pcs	0	JESD22-A102
Temperature Cycle	-65°C to 150°C , air to air,	1000cycles	924 pcs	0	JESD22-A104
HTSL	Temp = 150°C	1000 hours	693 pcs	0	JESD22-A103
IOL	Δ Tj = 100°C	15000 cycles	693 pcs	0	MIL-STD-750 Method 1037

Note: The reliability data presents total of available generic data up to the published date.

Note A: MSL (Moisture Sensitivity Level) 1 based on J-STD-020

II. Reliability Evaluation

FIT rate (per billion): 1.91

MTTF = 59839 years

The presentation of FIT rate for the individual product reliability is restricted by the actual burn-in sample size. Failure Rate Determination is based on JEDEC Standard JESD 85. FIT means one failure per billion hours.

Failure Rate = $\text{Chi}^2 \times 10^9 / [2 (N) (H) (Af)] = 1.91$

MTTF = $10^9 / \text{FIT} = 59839$ years

Chi² = Chi Squared Distribution, determined by the number of failures and confidence interval

N = Total Number of units from burn-in tests

H = Duration of burn-in testing

Af = Acceleration Factor from Test to Use Conditions (Ea = 0.7eV and Tuse = 55°C)

Acceleration Factor [**Af**] = $\text{Exp} [Ea / k (1/Tj u - 1/Tj s)]$

Acceleration Factor ratio list:

	55 deg C	70 deg C	85 deg C	100 deg C	115 deg C	130 deg C	150 deg C
Af	259	87	32	13	5.64	2.59	1

Tj s = Stressed junction temperature in degree (Kelvin), K = C+273.16

Tj u = The use junction temperature in degree (Kelvin), K = C+273.16

k = Boltzmann's constant, $8.617164 \times 10^{-5} \text{eV} / \text{K}$