

## Data Sheet

**HSMB-C190, HSMB-C170, HSMB-C110,  
HSMB-C150, HSMB-C191**



### Description

These Blue chip LEDs are designed in an industry standard package for ease of handling and use. Blue color chip LED is a new product that offers color differentiation for backlighting applications.

The HSMB-C150 has the industry standard 3.2 x 1.6 mm footprint that is excellent for all around use. The HSMB-C170 has the widely used 2.0 x 1.25 mm footprint. The HSMB-C190 and HSMB-C191 have the industry standard 1.6 x 0.8 mm footprint, and their low profiles (0.8 mm for HSMB-C190 and 0.6 mm for HSMB-C191) and wide viewing angles make these LEDs exceptional for backlighting applications.

The HSMB-C110 is a right-angle package with the universally accepted dimensions of 3.2 x 1.5 x 1.0 mm. This part is ideal for LCD backlighting and sidelighting applications.

All packages are compatible with IR reflow solder processes. The small size and wide viewing angle make these LEDs prime choices for backlighting applications and front panel illumination especially where space is a premium.

### Features

- Small Size
- Industry Standard Footprint
- Compatible with IR Solder
- Diffused Optics
- Operating Temperature Range of -30°C to +85°C
- Right Angle Package Available
- SiC Blue Color
- Available in 8 mm Tape on 7" (178 mm) Diameter Reels

### Applications

- Keypad Backlighting
- Push-Button Backlighting
- LCD Backlighting
- Symbol Backlighting
- Front Panel Indicator

### Device Selection Guide

Footprint (mm)	SiC Blue	Parts Per Reel
2.00 x 1.25	HSMB-C170	4000
1.60 x 0.80	HSMB-C190/C191	4000
3.20 x 1.50 <sup>[1]</sup>	HSMB-C110	3000
3.20 x 1.60	HSMB-C150	3000

#### Note:

1. Right-angle package.

*CAUTION: HSMB-C1xx LEDs are Class 1A ESD sensitive per JESD22-A114C.01. Please observe appropriate precautions during handling and processing. Refer to Avago Technologies Application Note AN-1142 for additional details.*

# Package Dimensions

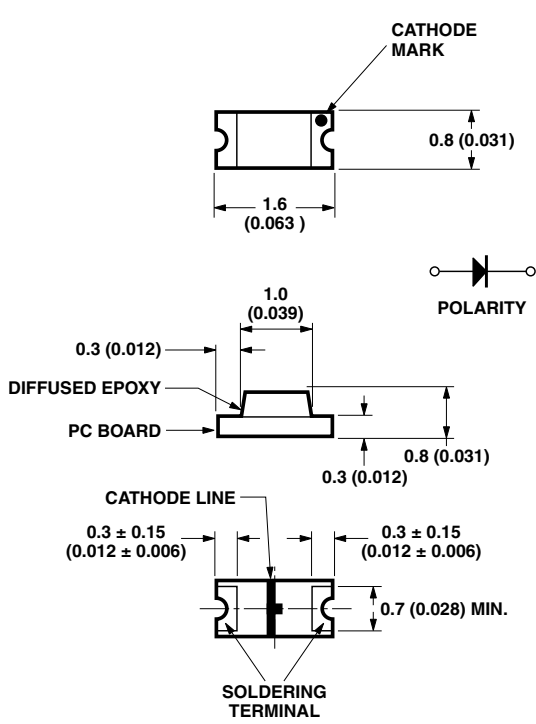

**HSMB-C190**

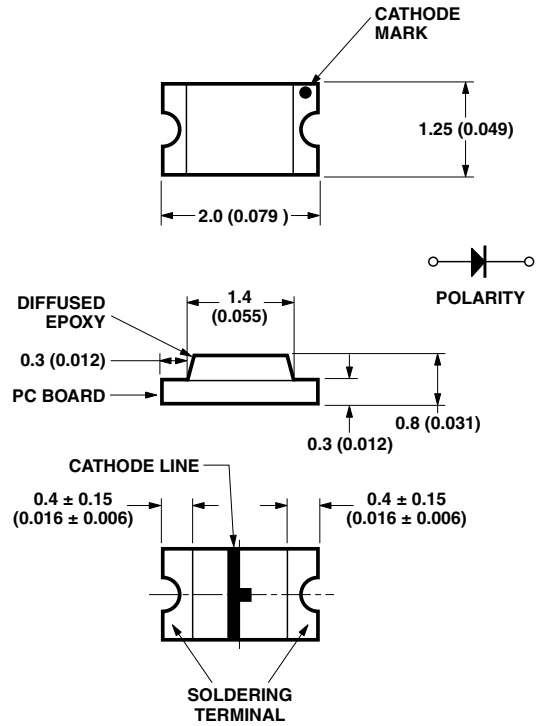

**HSMB-C170**

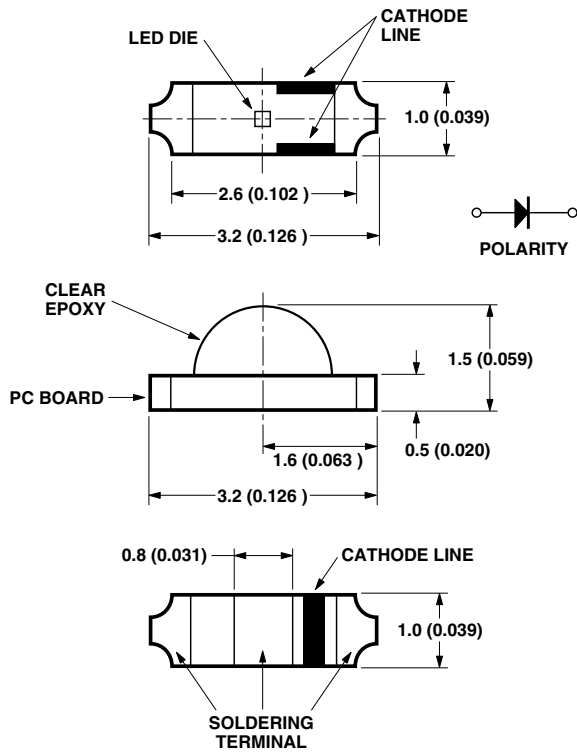

**HSMB-C110**

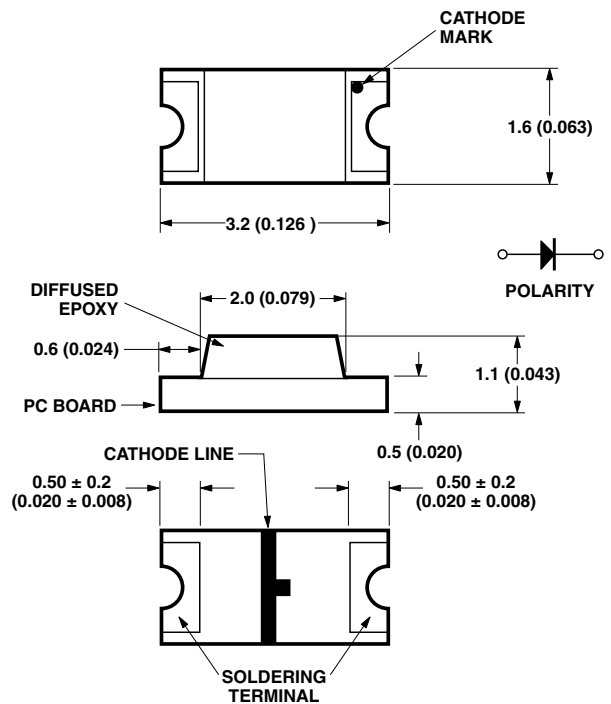

**HSMB-C150**

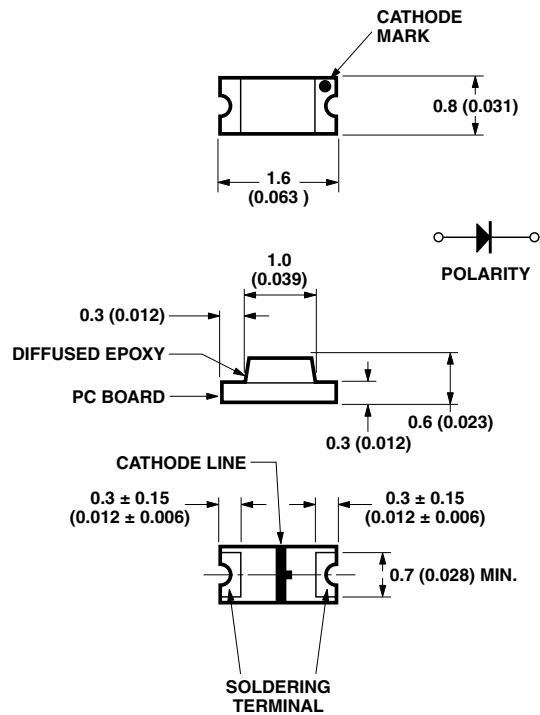

### HSMB-C191

**NOTE:**

1. ALL DIMENSIONS IN MILLIMETERS (INCHES).
2. TOLERANCE IS  $\pm 0.1$  mm ( $\pm 0.004$  IN.) UNLESS OTHERWISE SPECIFIED.

### Absolute Maximum Ratings at $T_A=25^\circ\text{C}$

Parameter	HSMB-C190/C170/C110/C150/C191	Units
DC Forward Current <sup>[1]</sup>	20	mA
Peak Pulsing Current <sup>[2]</sup>	100	mA
Power Dissipation	92	mW
Reverse Voltage ( $I_R = 100 \mu\text{A}$ )	5	V
Maximum LED Junction Temperature	95	$^\circ\text{C}$
Operating Temperature Range	-30 to +85	$^\circ\text{C}$
Storage Temperature Range	-40 to +85	$^\circ\text{C}$
Soldering Temperature	See reflow soldering profile (Figure 7 & 8)	

**Notes:**

1. Derate linearly as shown in Figure 4 for temperature above  $25^\circ\text{C}$ .
2. Pulse condition of 1/10 duty and 0.1 msec. width.

## Optical Characteristics at T<sub>A</sub>=25°C

Part No.	Color	Luminous Intensity <sup>[1]</sup> I <sub>v</sub> (mcd) @ 20 mA		Peak Wavelength λ <sub>peak</sub> (nm)	Dominant Wavelength λ <sub>d</sub> (nm)	Viewing Angle 2θ <sub>1/2</sub> (degrees) <sup>[2]</sup>
		Min.	Typ.	Typ.	Typ.	Typ.
HSMB-C190/C170/C150/C191	SiC Blue	1.80	6.0	428	466	170
HSMB-C110	SiC Blue	1.80	6.5	428	466	130

### Notes:

- The luminous intensity, I<sub>v</sub>, is measured at the peak of the spatial radiation pattern, which may not be aligned with the mechanical axis of the lamp package.
- u<sub>1/2</sub> is the off-axis angle where the luminous intensity is 1/2 the peak intensity.

## Electrical Characteristics at T<sub>A</sub>=25°C

Part No.	Forward Voltage V <sub>F</sub> (Volts) @ I <sub>F</sub> = 20 mA		Reverse Breakdown V <sub>R</sub> (Volts) @ I <sub>R</sub> = 100 μA	Thermal Resistance R <sub>θJ-P</sub> (°C/W)	Capacitance C (pF) @ V <sub>F</sub> = 0 V, f = 1 MHz
	Typ.	Max.	Min.	Typ.	Typ.
HSMB-C190/C170/C150/C191	4.0	4.6	5	300	67
HSMB-C110	4.0	4.6	5	300	67

V<sub>F</sub> Tolerance: ±0.1 V

## Light Intensity (I<sub>v</sub>) Bin Limits<sup>[1]</sup>

Blue Color Bins <sup>[1]</sup>		
Dom. Wavelength (nm)		
Bin ID	Min.	Max.
A	460.0	465.0
B	465.0	470.0
C	470.0	475.0
D	475.0	480.0

Tolerance: ±1 nm

### Note:

- Bin categories are established for classification of products. Products may not be available in all categories. Please contact your Avago representative for information on currently available bins.

Intensity (mcd)			Intensity (mcd)		
Bin ID	Min.	Max.	Bin ID	Min.	Max.
A	0.11	0.18	N	28.50	45.00
B	0.18	0.29	P	45.00	71.50
C	0.29	0.45	Q	71.50	112.50
D	0.45	0.72	R	112.50	180.00
E	0.72	1.10	S	180.00	285.00
F	1.10	1.80	T	285.00	450.00
G	1.80	2.80	U	450.00	715.00
H	2.80	4.50	V	715.00	1125.00
J	4.50	7.20	W	1125.00	1800.00
K	7.20	11.20	X	1800.00	2850.00
L	11.20	18.00	Y	2850.00	4500.00
M	18.00	28.50			

Tolerance: ±15%

### Note:

- Bin categories are established for classification of products. Products may not be available in all categories. Please contact your Avago representative for information on currently available bins.
- The I<sub>v</sub> binning specification set-up is for lowest allowable I<sub>v</sub> binning only. There is no upper I<sub>v</sub> bin limits.

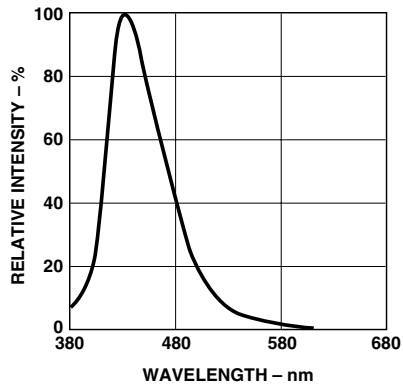

Figure 1. Relative Intensity vs. Wavelength.

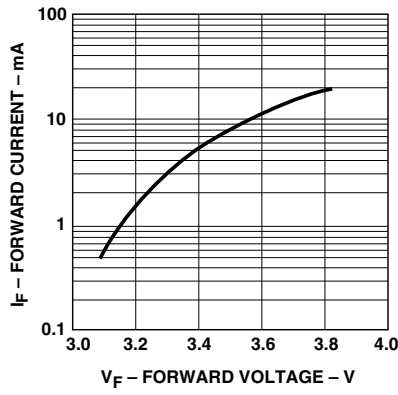

Figure 2. Forward Current vs. Forward Voltage.

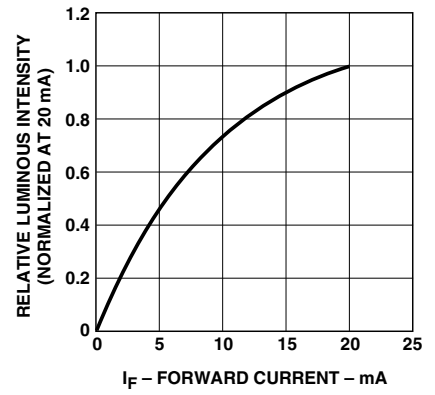

Figure 3. Relative Luminous Intensity vs. Forward Current.

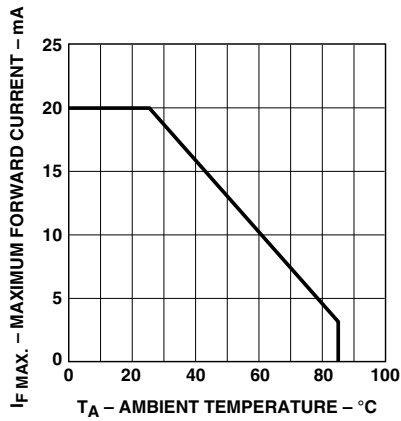

Figure 4. Maximum Forward Current vs. Ambient Temperature.

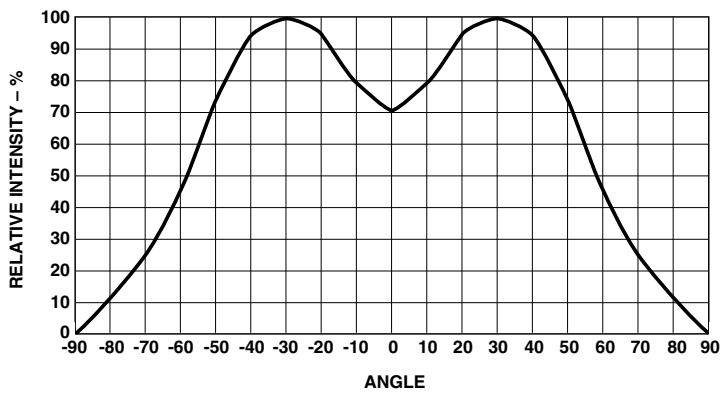
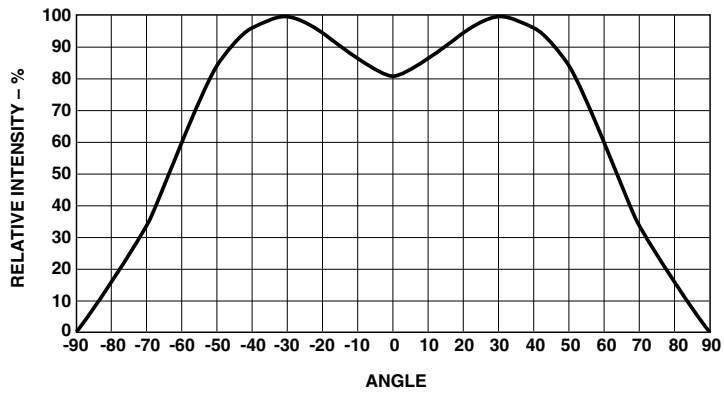

Figure 5. Relative Intensity vs. Angle for HSMB-C110.

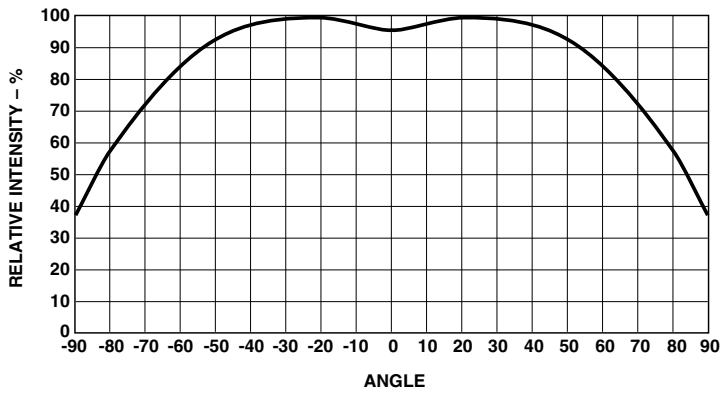

Figure 6. Relative Intensity vs. Angle for HSMB-C170, HSMB-C190, HSMB-C150, and HSMB-C191.

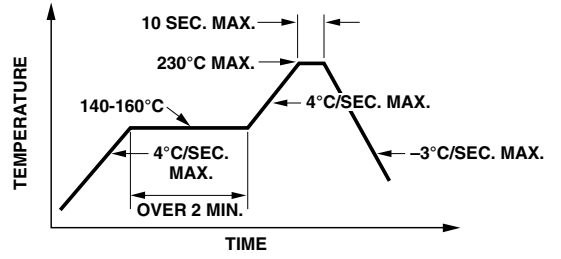

Figure 7. Recommended reflow soldering profile.

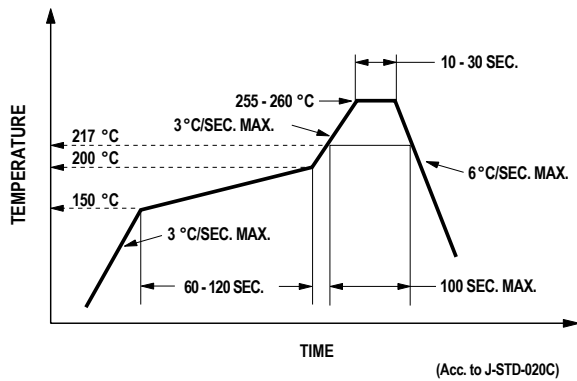

Figure 8. Recommended Pb-free Reflow Soldering Profile.

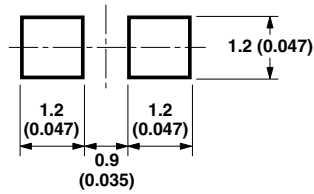

Figure 9. Recommended Soldering Pattern for HSMB-C170.

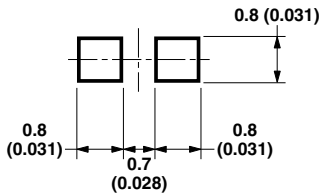

Figure 10. Recommended Soldering Pattern for HSMB-C190 and C191.

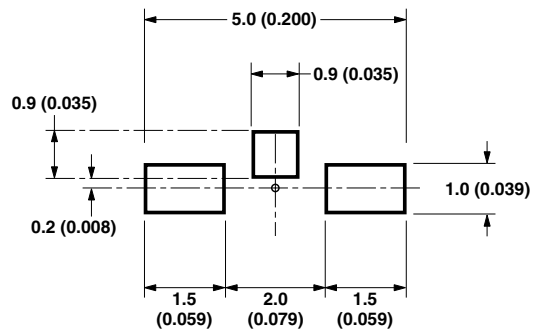

Figure 11. Recommended Soldering Pattern for HSMB-C110.

**Note:**

1. All dimensions in millimeters (inches).

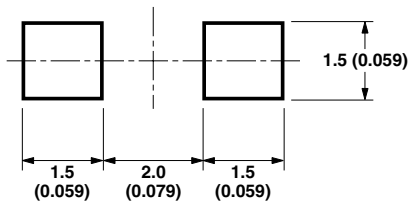

Figure 12. Recommended Soldering Pattern for HSMB-C150.

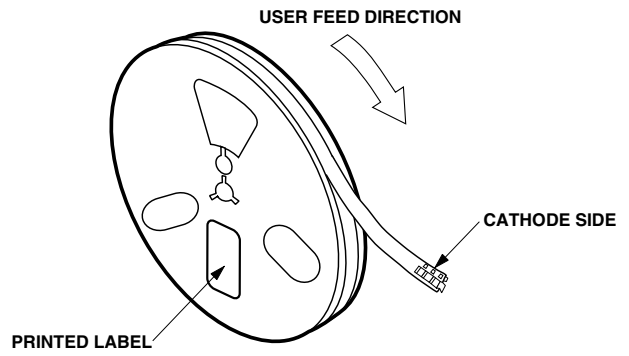

Figure 13. Reeling Orientation.

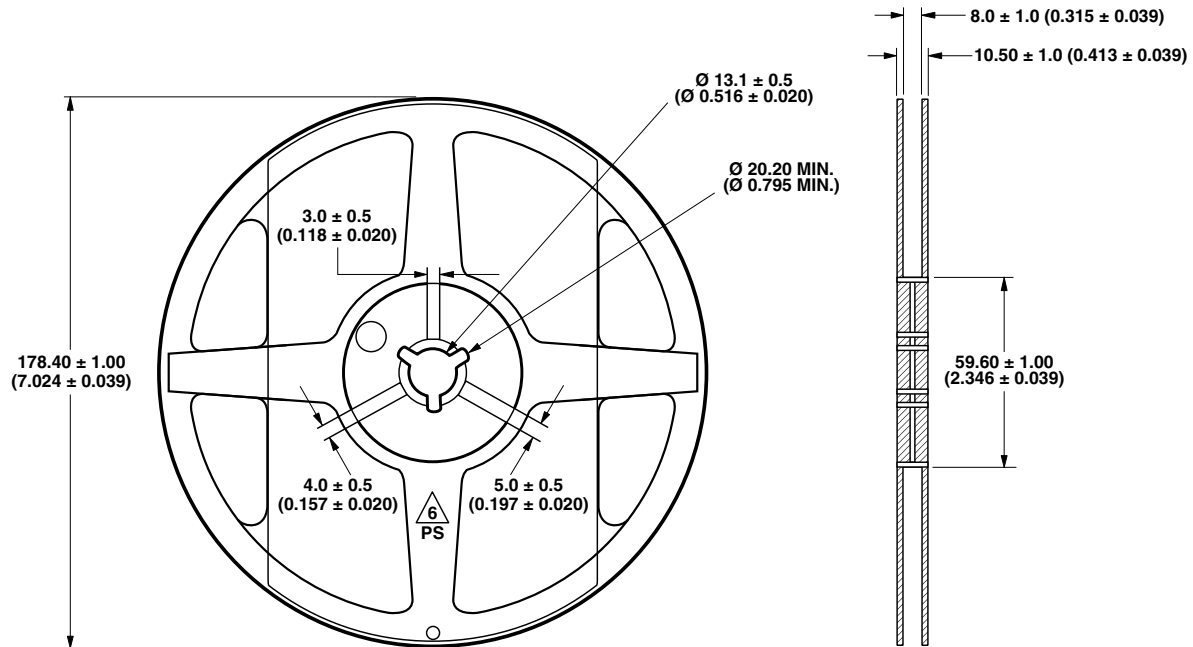

Figure 14. Reel Dimensions.

**Note:**

1. All dimensions in millimeters (inches).

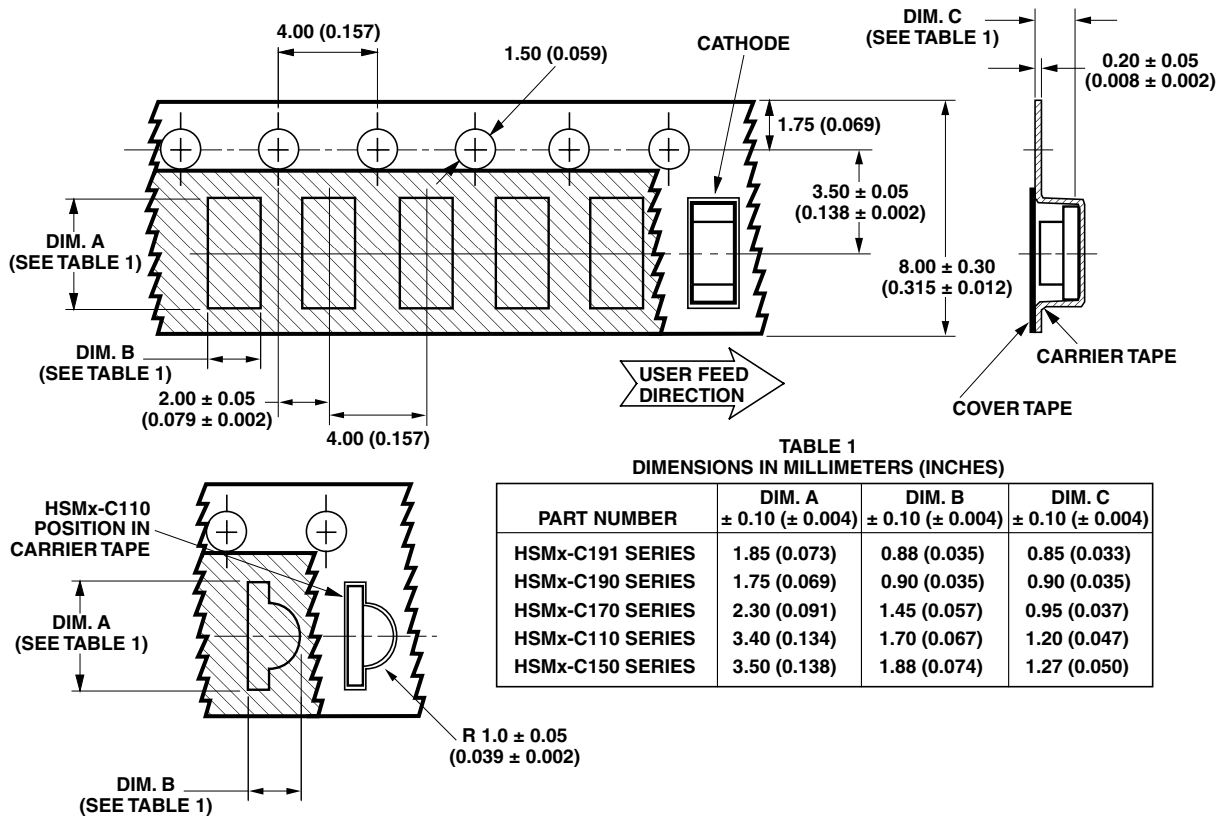

Figure 15. Tape Dimensions.

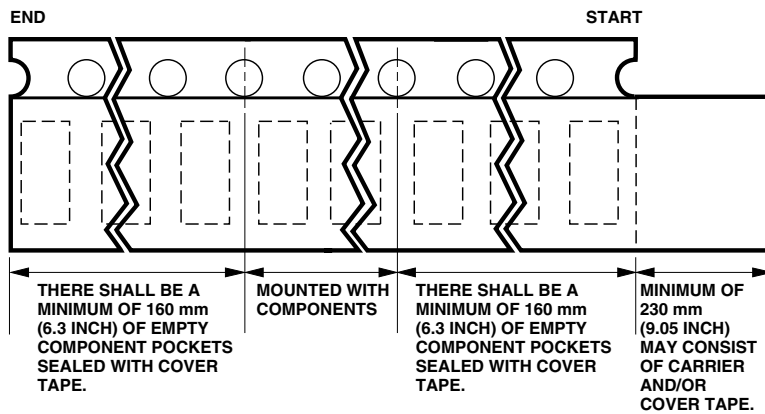

Figure 16. Tape Leader and Trailer Dimensions.

**Notes:**

1. All dimensions in millimeters (inches).
2. Tolerance is  $\pm 0.1$  mm ( $\pm 0.004$  in.) unless otherwise specified.



**Reflow Soldering:**

For more information on reflow soldering, refer to Application Note AN-1060, Surface Mounting SMT LED Indicator Components.

**Storage Condition:** 5 to 30°C @ 60%RH max.

Baking is required before mounting, if:

1. Humidity Indicator Card is > 10% when read at  $23 \pm 5^\circ\text{C}$ .
2. Device expose to factory conditions <30°C/60%RH more than 672 hours.

**Recommended baking condition:**  $60 \pm 5^\circ\text{C}$  for 20 hours.

For product information and a complete list of distributors, please go to our website: [www.avagotech.com](http://www.avagotech.com)

Avago, Avago Technologies, and the A logo are trademarks of Avago Technologies Limited in the United States and other countries.  
Data subject to change. Copyright © 2006 Avago Technologies Limited. All rights reserved. Obsoletes 5989-0417EN  
AV02-0613EN - December 28, 2007

**AVAGO**  
TECHNOLOGIES