



Rayovac Stock Number: 815, 815 OEM

Name: LR6 AA High Energy Alkaline Battery

Specifications

Chemistry: Alkaline (Zinc-Manganese Dioxide)
Designation: ANSI - 15A, IEC – LR6
Nominal Voltage: 1.5 volts
Approximate Weight: 0.8 Oz (24.4 grams)
Approximate Volume: 0.45 CU IN (7.4 cc)
Operating Temp: -30°C to 55°C (-20°F to 130°F)
Shelf Life: 10 years at 21°C
Terminals: Flat Contact
Case material: Plastic Film
Environmental: No mercury added formulation. Meets Environmental Protection Agency (EPA) requirements for landfill disposal.
[Rayovac Material Safety Sheets](#)

ANSI / IEC Standard Dimensions

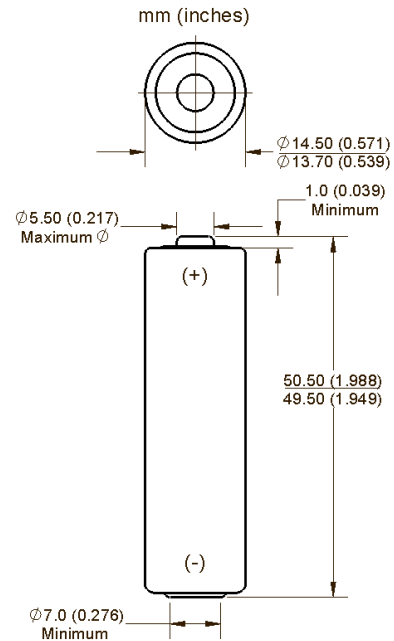

Typical Service Life – ANSI Application Tests

Application and Duty Cycle	Discharge Load	Service
Digital Camera (2 sec Load 1, 28 sec Load 2) 5 min/hr	Load 1: 1.5W Load 2: 0.65W	100 pulses
Grooming 2 min/hr	750 mA	1.25 hours
Lighting 4 min/hr, 8 hr/day	3.9 Ω	7.85 hours
Toy 1 h/day	3.9 Ω	8.47 hours
CD / Games 1 hr/day	250 mA	9.17 hours
Digital Audio 1 hr/day	100 mA	26.5 hours
Remote/Radio/Clock 1 hr on / 7 hr off	50 mA	53.3 hours

Discharge Curves (Continuous Load)

