

LINOS F-Theta-Ronar Lens

f = 254mm, 1064nm

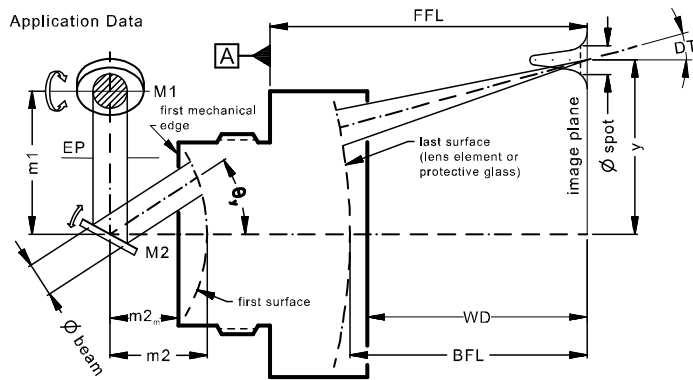

Part number	4401-288-000-20		
Design wavelength	λ	(nm)	1064
Effective focal length	EFL	(mm)	254.4
Back focal length	BFL	(mm)	299.1
Working distance	WD	(mm)	296.2
Flange focal length	FFL	(mm)	344.8
Beam diameter 1/e ² truncated	$\varnothing_{\text{beam}}$	(mm)	20.0
Recommended mirror distance m1	m1	(mm)	25.6
Recommended mirror distance m2	m2	(mm)	23.0
Recommended mirror distance m2 _{mechanical}	m2 _m	(mm)	18.5
Scan angle	$\pm\theta_{x,y}$	(°)	17.7
Scan area (edge length of scan field)	2x * 2y	(mm ²)	157 x 157
Spot diameter	$\varnothing_{\text{spot}}$	(μm)	25
Total transmission @ 1064nm	T	(%)	> 96
LIDT coating @ 1064nm, 9ns, 100Hz		(J/cm ²)	10
Focused back reflex positions from first surface		(mm)	14.2; 19.6; 52.6; 71.3; 72.4; 142.8; 457.8
Weight		(g)	1340
Protective glass	PG		4401-288-005-01

Optical parameters calculated for a 1-mirror system
 Subject to technical change

Mechanical drawing

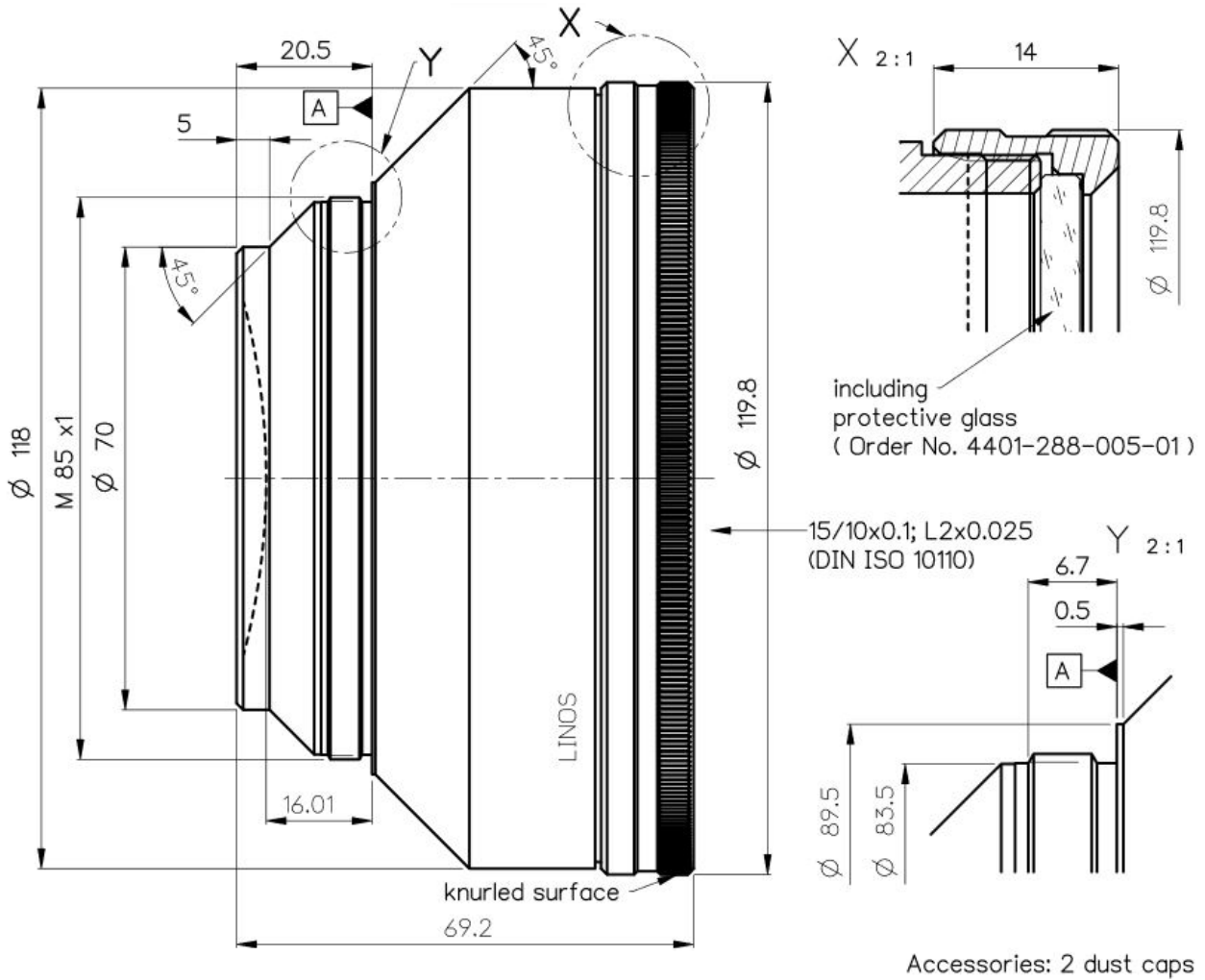

Dimensions without tolerances are nominal values and illustration not to scale

Notes



For technical explanations, see our homepage.

In a 1-mirror system, the entrance pupil (EP) is the position of the scan mirror. In a 2-mirror system, it is the point where the scan mirrors should be placed around symmetrically to reach specified performance.