

Address:  
Block 9, Shuiwei Ind Zone, Shuiwei New  
Village, Dalang, Longhua, Shenzhen,  
Guangdong, China 518109

Tel: (86)755-28121370/ 28121371/28109416/28109419  
Fax: (86)755-28109417  
E-mail: rd@horn.com.cn  
Website: www.horn.com.cn

**CUSTOMER: Digi-Key Corporation**

## APPROVAL SHEET

PRODUCT NAME	PART NUMBER	DIMENSION	REMARK
Electret Condenser Microphone	EM6022P-42BC10&33	Ø6.0×2.2(mm)	D.S.PCB

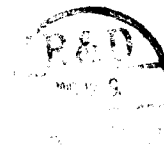
APPROVED BY	CHECKED BY	ISSUED BY
		

**APPROVED BY:**

**DATE:**

Address:  
Block 9, Shuiwei Ind Zone, Shuiwei New  
Village, Dalang, Longhua, Shenzhen,  
Guangdong, China 518109

Tel: (86)755-28121370/ 28121371/28109416/28109419  
Fax: (86)755-28109417  
E-mail: rd@horn.com.cn  
Website: www.horn.com.cn

## SPECIFICATION

Item	Symbol	Test conditions	Min	Standard	Max	Unit
Sensitivity	S	f=1KHz. Pin=1Pa	-44	-42	-40	dB 0dB=1V/Pa
Directivity	Omnidirectional					
Impedance	Zout				2.2	KΩ
Input sound pressure level	S.P.L				100	dB
Operation voltage	Vs	-	1.0	2	10	V
Current consumption	I	f=1KHz. Pin=1Pa			500	μA
Sensitivity reduction	ΔS	f=1KHz. Pin=1Pa Vs=2→1.5V			-3	dB
S/N ratio	S/N(A)	f=1KHz. Pin=1Pa A=curve	60			dB

### Measurement Circuit (Test Condition Vs=2V RL=2.2KΩ)

Ta=20°C R.H=65%)

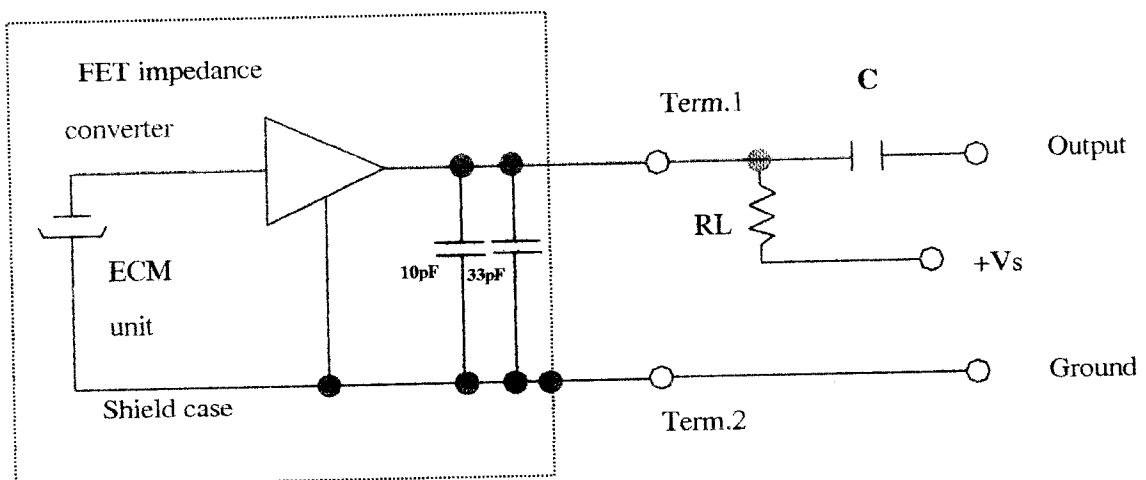

PART NUMBER : EM6022P-42BC10&33

Address:  
Block 9, Shuiwei Ind Zone, Shuiwei New  
Village, Dalang, Longhua, Shenzhen,  
Guangdong, China 518109

Tel: (86)755-28121370/ 28121371/28109416/28109419  
Fax: (86)755-28109417  
E-mail: rd@horn.com.cn  
Website: www.horn.com.cn

## Dimensional Drawing

unit: mm

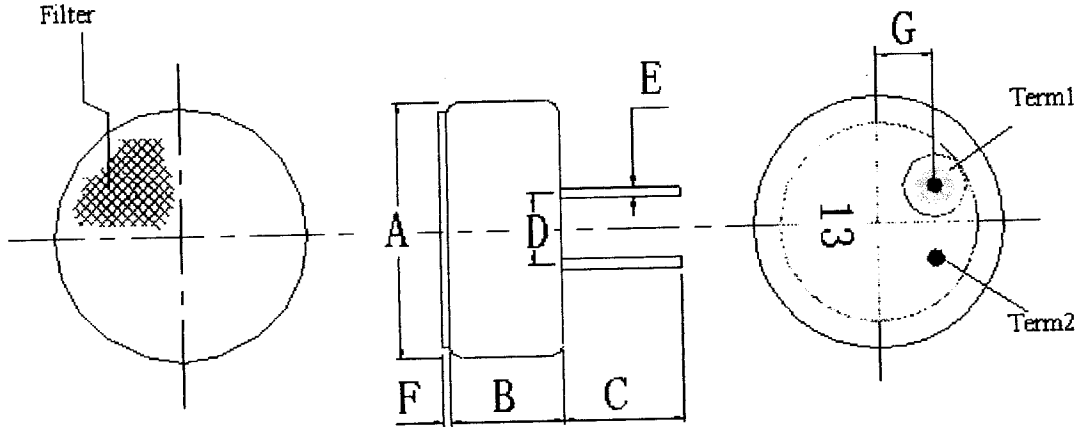

PART	MIN	STANDARD	MAX	REMARK
A	Ø5.9	Ø6.0	Ø6.1	
B	2.0	2.2	2.4	
C	2.6	2.8	3.0	
D	1.8	1.9	2.0	
E	0.3	0.4	0.5	
F	0.1	0.2	0.3	
G	-	-	1.0	

## Typical Frequency Response Curve

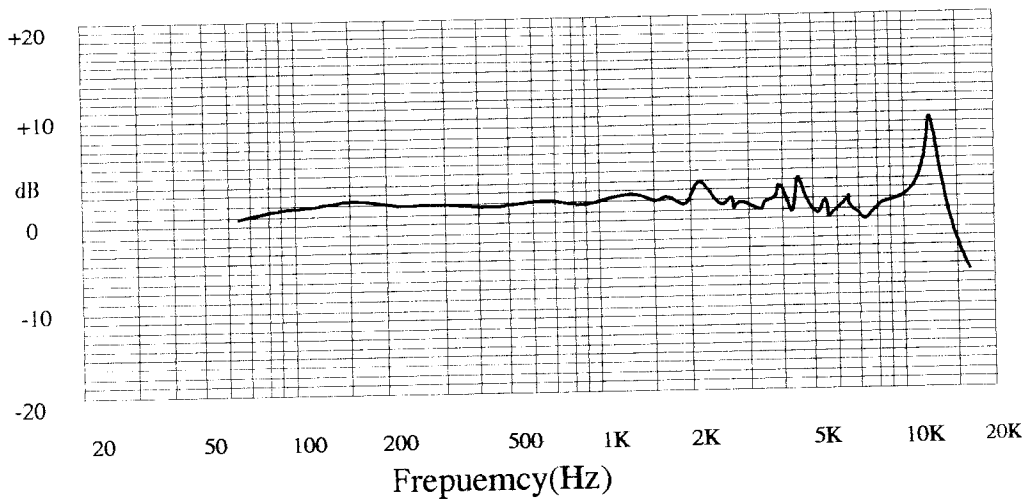

PART NUMBER : EM6022P-42BC10&33

Address:  
Block 9, Shuiwei Ind Zone, Shuiwei New  
Village, Dalang, Longhua, Shenzhen,  
Guangdong, China 518109

Tel: (86)755-28121370/ 28121371/28109416/28109419  
Fax: (86)755-28109417  
E-mail: rd@horn.com.cn  
Website: www.horn.com.cn

## Ambient condition

### (1) Operating condition

Ambient temperature:  $-10^{\circ}\text{C} \sim +45^{\circ}\text{C}$   
Relative humidity:  $\leq 85\%$

### (2) Storage condition

Ambient temperature:  $-20^{\circ}\text{C} \sim +60^{\circ}\text{C}$   
Relative humidity:  $45\% \sim 75\%$

## Reliability Test

### 1) Vibration Test

To be no interference in operation after vibration of full amplitude 2mm for 30 minutes at three axis. the sensitivity to be within  $\pm 3\text{dB}$  from initial sensitivity.

### 2) Drop test

To be no interference in operation after dropped to concrete floor each time from 1 meter height of three directions in state of packing, the sensitivity to be within  $\pm 3\text{dB}$  from initial sensitivity.

### 3) High Temperature Storage:

To be no interference in operation after high temperature test  $70^{\circ}\text{C} \pm 3^{\circ}\text{C}$  for 48 hours. The sensitivity to be within  $\pm 3\text{dB}$  from initial sensitivity.

### 4) Isotherm & Iso-humidity Storage

To be no interference in operation after storage test at temperature  $60^{\circ}\text{C} \pm 2^{\circ}\text{C}$  and relative humidity ( $93 \pm 3\%$ ) for 48 hours, the sensitivity to be within  $\pm 3\text{dB}$  from initial sensitivity, the test is performed at temperature  $20^{\circ}\text{C}$  after operation for 6 hours.

### 5) Low Temperature Storage

To be no interference in operation after test at temperature  $-20^{\circ}\text{C} \pm 3^{\circ}\text{C}$  for 48 hours, the sensitivity to be within  $\pm 3\text{dB}$  from initial sensitivity.

### 6) Temperature Cycle Test

After exposure at  $+55^{\circ}\text{C}$  for 1 hour, at  $20^{\circ}\text{C}$  for 1 hour, at  $-10^{\circ}\text{C}$  for 1 hour, at  $20^{\circ}\text{C}$  for 1 hour, with 5 cycles. Change of sensitivity within  $\pm 3\text{dB}$  from initial measuring should be done after 2 hours exposed to  $20^{\circ}\text{C} \pm 2^{\circ}\text{C}$ .

### 7) Collision Test

After collided with the acceleration  $100 \pm 10\text{m/s}$ , at the vertical & horizontal directions for  $1000 \pm 10$  times. at the state of packing. Change of sensitivity within  $\pm 3\text{dB}$  from initial.

**TEST RESULT OF SAMPLES**

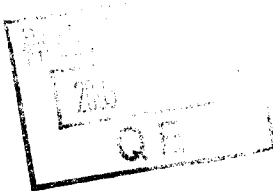
NO.	1KHz (dB)	CURRENT (mA)	NOTES
1	-42	0.23	<p>(1KHz、0dB=1V/Pa)</p> 
2	-41.9	0.23	
3	-41.7	0.25	
4	-41.6	0.2	
5	-42.5	0.21	
6	-42.3	0.23	
7	-41.8	0.28	
8	-41.6	0.21	
9	-42	0.2	
10	-41.9	0.2	
11	-41.5	0.19	
12	-42.3	0.23	
13	-42.3	0.23	
14	-41.8	0.2	
15	-41.6	0.2	

Customer: Digi-Key Corporation

Date: 2003.12.09

Part number: EM6022P-42BC10&33

Sensitivity: -42±2dB

Test condition: 2.2K Ω 2V

Tester: G1

SHENZHEN HORN ELECTROACOUSTIC TECHNOLOGY CO., LTD.  
X:1.0000kHz \*Y:-41.86dB\* ZA:Live Curve SSR Fund.

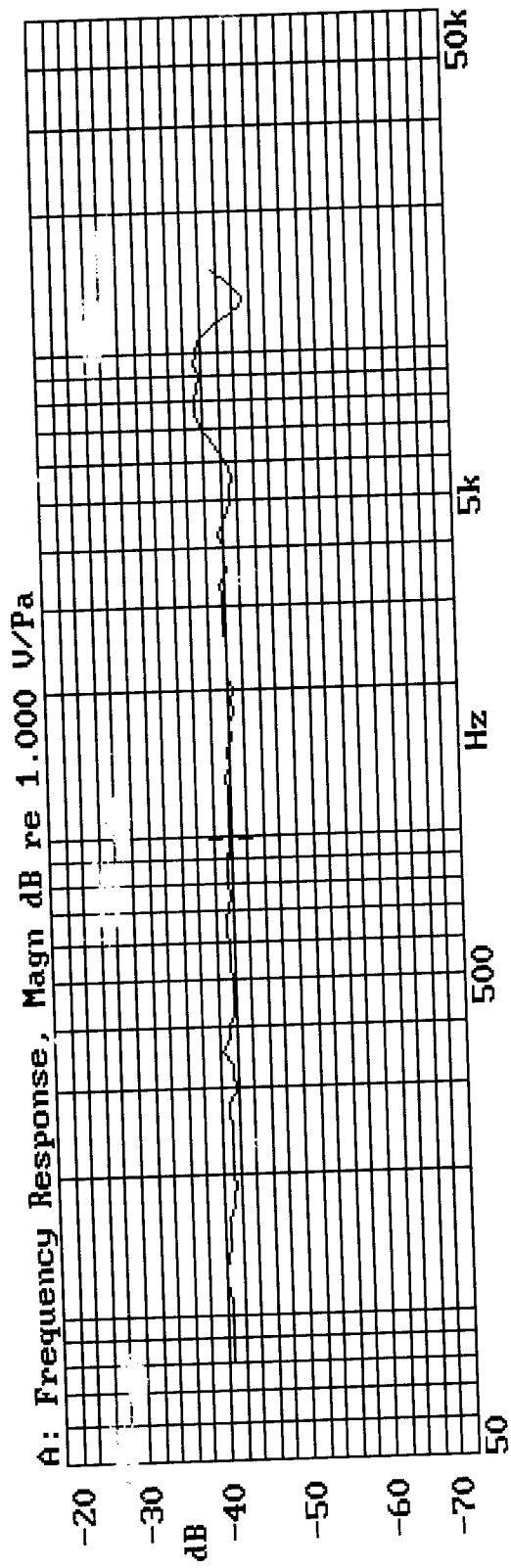

MODEL: EM6022P-42BC10&33  
CODE: 2#  
SENSITIVITY: -41.86dB (1KHz)  
TEST CONDITION: 2.2KΩ 2V



08-DEC-2003 16:16:32

Mode: SSR



Electret Condenser Microphone Units

深圳市豪恩电声科技有限公司

SHENZHEN HORN ELECTROACOUSTIC TECHNOLOGY CO., LTD

TEL: 86-755-28121370/28121371/28109416/28109419

FAX: 86-755-28109417

Website: www.horn.com.cn

E-mail: rd@horn.com.cn

## Certificate of Confirmed Products

Date: Dec. 07. 2003

NO: W031206001

SUPPLIER	HORN	BUYER	Digi-Key Corporation	
TITLE	ECM	MODEL	EM6022P-42BC10&33	
SIZE	φ 6.0 × 2.2mm	TEST CONDITION	2.2K Ω 2V	
QUANTITY		SAMPLE: 15PCS		
<b>SPECIFICATIONS</b>				
Sensitivity		-42 ± 2dB (0dB=1V/Pa. 1KHz )		
Directivity		Omnidirectional		
Impedance		Low impedance		
Standard operation voltage		2V		
Operation voltage		1. 0-10V		
Current consumption		Max 500uA		
Maximum input S.P.L		100dB		
S/N ratio		More than 60 dB		
Sensitive reduction		within-3dB at 1.5V		
The test result from customers		Signature: _____ . _____ . 2003		
Final confirmed	Pass	Refuse	Accepted basis on	
Remarks				

\*\*\*\*\* The form must be confirmed by return fax after your test as your best regards! \*\*\*\*\*