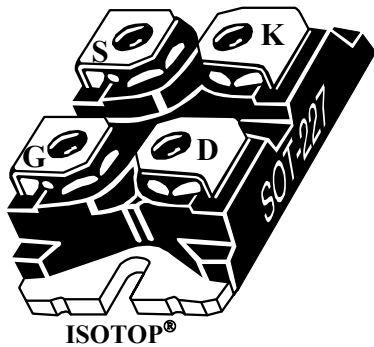
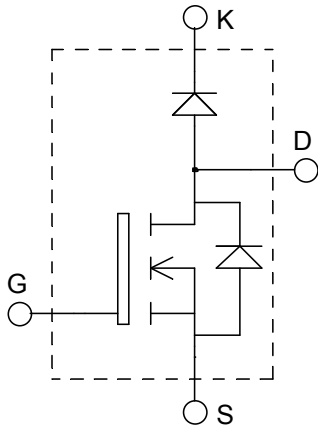

**ISOTOP[®] Boost chopper
MOSFET Power Module**

$V_{DSS} = 100V$
 $R_{DSon} = 11m\Omega \text{ max @ } T_j = 25^\circ C$
 $I_D = 142A \text{ @ } T_c = 25^\circ C$

Application

- AC and DC motor control
- Switched Mode Power Supplies
- Power Factor Correction
- Brake switch

Features

- Power MOS V[®] MOSFETs
 - Low R_{DSon}
 - Low input and Miller capacitance
 - Low gate charge
 - Fast intrinsic diode
 - Avalanche energy rated
 - Very rugged
- ISOTOP[®] Package (SOT-227)
- Very low stray inductance
- High level of integration

Benefits

- Outstanding performance at high frequency operation
- Direct mounting to heatsink (isolated package)
- Low junction to case thermal resistance
- Very rugged
- Low profile
- RoHS Compliant

Absolute maximum ratings

Symbol	Parameter	Max ratings	Unit	
V_{DSS}	Drain - Source Breakdown Voltage	100	V	
I_D	Continuous Drain Current	$T_c = 25^\circ C$	142	
		$T_c = 80^\circ C$	106	
I_{DM}	Pulsed Drain current	576		
V_{GS}	Gate - Source Voltage	± 30	V	
R_{DSon}	Drain - Source ON Resistance	11	$m\Omega$	
P_D	Maximum Power Dissipation	$T_c = 25^\circ C$	450	
I_{AR}	Avalanche current (repetitive and non repetitive)	144	A	
E_{AR}	Repetitive Avalanche Energy	50	mJ	
E_{AS}	Single Pulse Avalanche Energy	2500		
I_{FAV}	Maximum Average Forward Current	Duty cycle=0.5	$T_c = 90^\circ C$	A
I_{FRMS}	RMS Forward Current (Square wave, 50% duty)		47	

CAUTION: These Devices are sensitive to Electrostatic Discharge. Proper Handling Procedures Should Be Followed.

All ratings @ $T_j = 25^\circ\text{C}$ unless otherwise specified

Electrical Characteristics

Symbol	Characteristic	Test Conditions	Min	Typ	Max	Unit
I_{DSS}	Zero Gate Voltage Drain Current	$V_{GS} = 0V, V_{DS} = 100V$			250	μA
		$V_{GS} = 0V, V_{DS} = 80V$			1000	
$R_{DS(on)}$	Drain – Source on Resistance	$V_{GS} = 10V, I_D = 71A$			11	$\text{m}\Omega$
$V_{GS(th)}$	Gate Threshold Voltage	$V_{GS} = V_{DS}, I_D = 2.5\text{mA}$	2		4	V
I_{GSS}	Gate – Source Leakage Current	$V_{GS} = \pm 20V, V_{DS} = 0V$			± 100	nA

Dynamic Characteristics

Symbol	Characteristic	Test Conditions	Min	Typ	Max	Unit
C_{iss}	Input Capacitance	$V_{GS} = 0V$ $V_{DS} = 25V$ $f = 1\text{MHz}$		8600		pF
C_{oss}	Output Capacitance			3200		
C_{rss}	Reverse Transfer Capacitance			1180		
Q_g	Total gate Charge	$V_{GS} = 10V$ $V_{Bus} = 50V$ $I_D = 50A @ T_j = 25^\circ\text{C}$		300		nC
Q_{gs}	Gate – Source Charge			95		
Q_{gd}	Gate – Drain Charge			110		
$T_{d(on)}$	Turn-on Delay Time	$V_{GS} = 15V$ $V_{Bus} = 50V$ $I_D = 142A @ T_j = 25^\circ\text{C}$ $R_G = 0.6\Omega$		16		ns
T_r	Rise Time			48		
$T_{d(off)}$	Turn-off Delay Time			51		
T_f	Fall Time			9		

Chopper diode ratings and characteristics

Symbol	Characteristic	Test Conditions	Min	Typ	Max	Unit
V_F	Diode Forward Voltage	$I_F = 30A$		1.1	1.15	V
		$I_F = 60A$		1.4		
		$I_F = 30A$	$T_j = 125^\circ\text{C}$		0.9	
I_{RM}	Maximum Reverse Leakage Current	$V_R = 200V$	$T_j = 25^\circ\text{C}$		250	μA
		$V_R = 200V$	$T_j = 125^\circ\text{C}$		500	
C_T	Junction Capacitance	$V_R = 200V$		94		pF
t_{rr}	Reverse Recovery Time	$I_F = 1A, V_R = 30V$ $di/dt = 200A/\mu\text{s}$	$T_j = 25^\circ\text{C}$	21		ns
	Reverse Recovery Time		$T_j = 25^\circ\text{C}$	24		
			$T_j = 125^\circ\text{C}$	48		
I_{RRM}	Maximum Reverse Recovery Current	$I_F = 30A$ $V_R = 133V$ $di/dt = 200A/\mu\text{s}$	$T_j = 25^\circ\text{C}$	3		A
			$T_j = 125^\circ\text{C}$	6		
			$T_j = 25^\circ\text{C}$	33		
Q_{rr}	Reverse Recovery Charge	$I_F = 30A$ $V_R = 133V$ $di/dt = 1000A/\mu\text{s}$	$T_j = 25^\circ\text{C}$	150		nC
			$T_j = 125^\circ\text{C}$	31		
t_{rr}	Reverse Recovery Time	$I_F = 30A$ $V_R = 133V$ $di/dt = 1000A/\mu\text{s}$	$T_j = 125^\circ\text{C}$	31		ns
Q_{rr}	Reverse Recovery Charge			335		nC
I_{RRM}	Maximum Reverse Recovery Current				19	

Thermal and package characteristics

Symbol	Characteristic	Min	Typ	Max	Unit
R _{thJC}	Junction to Case Thermal Resistance	MOSFET		0.28	°C/W
		Diode		1.21	
R _{thJA}	Junction to Ambient (IGBT & Diode)			20	
V _{ISOL}	RMS Isolation Voltage, any terminal to case t = 1 min, 50/60Hz	2500			V
T _J , T _{STG}	Storage Temperature Range	-55		150	°C
T _L	Max Lead Temp for Soldering: 0.063" from case for 10 sec			300	
Torque	Mounting torque (Mounting = 8-32 or 4mm Machine and terminals = 4mm Machine)			1.5	N.m
Wt	Package Weight		29.2		g

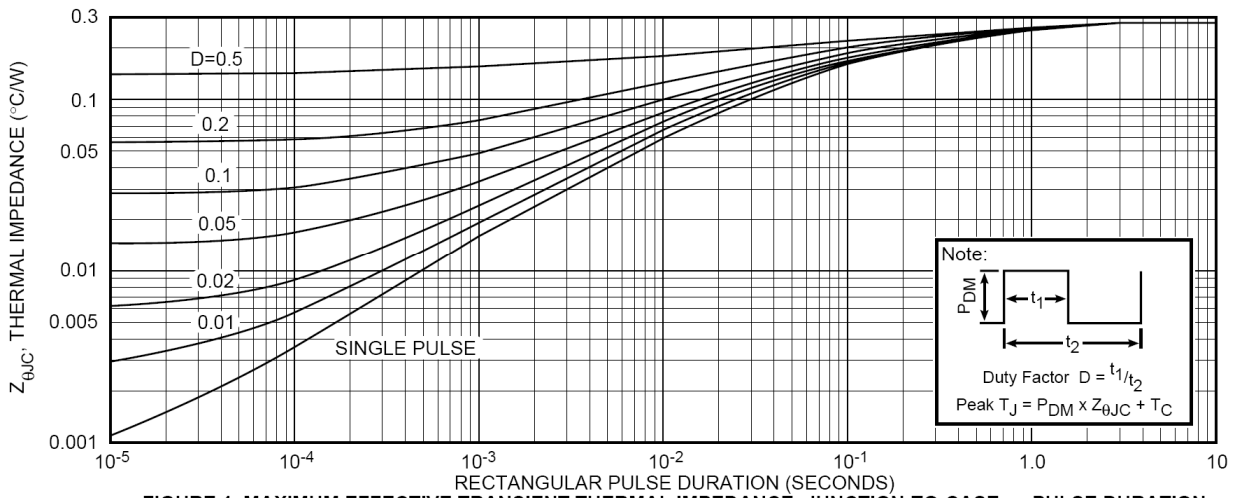
Typical MOSFET Performance Curve

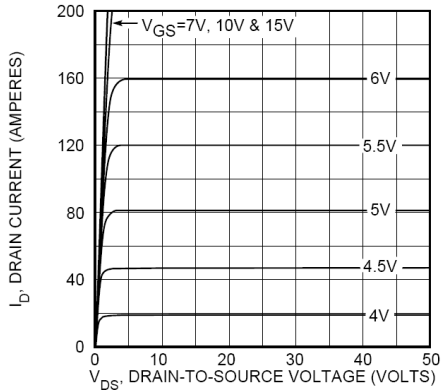

FIGURE 2, TYPICAL OUTPUT CHARACTERISTICS

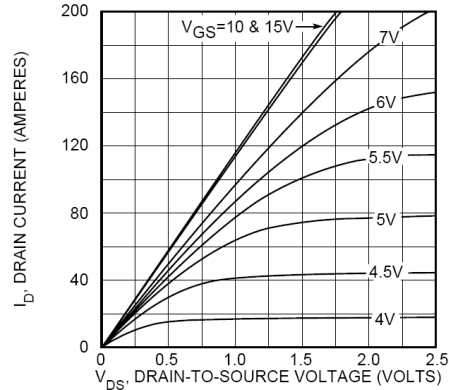

FIGURE 3, TYPICAL OUTPUT CHARACTERISTICS

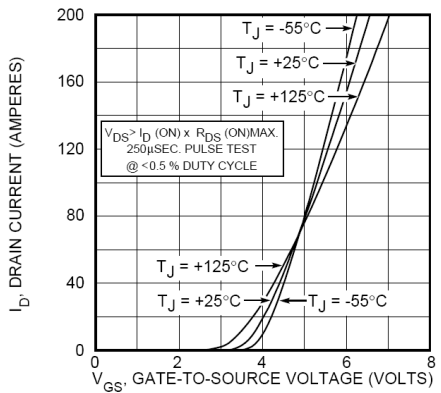

FIGURE 4, TYPICAL TRANSFER CHARACTERISTICS

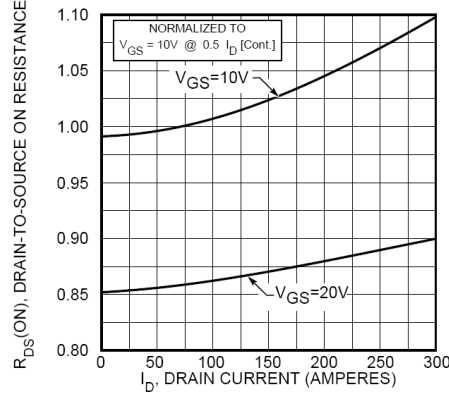

FIGURE 5, $R_{DS(ON)}$ vs DRAIN CURRENT

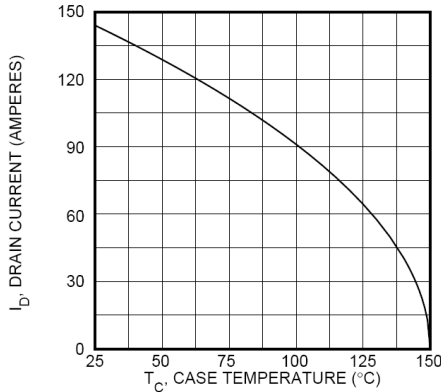

FIGURE 6, MAXIMUM DRAIN CURRENT vs CASE TEMPERATURE

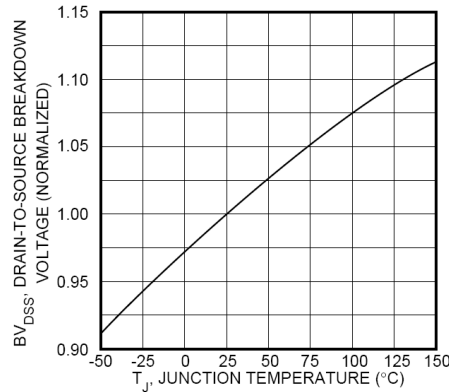

FIGURE 7, BREAKDOWN VOLTAGE vs TEMPERATURE

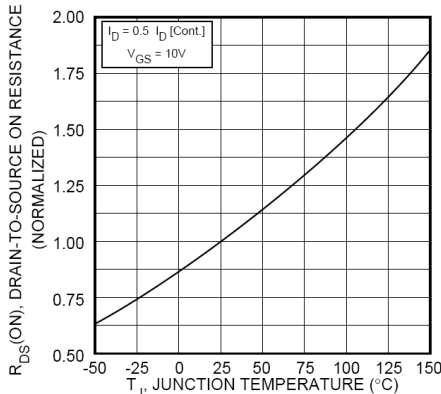

FIGURE 8, ON-RESISTANCE vs. TEMPERATURE

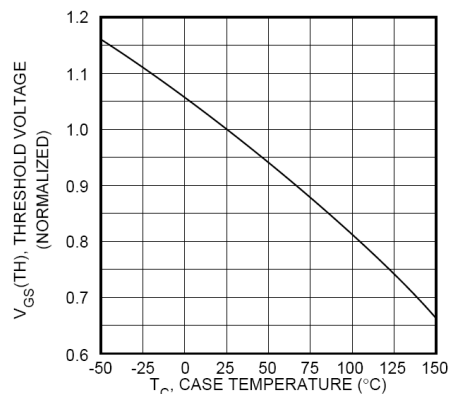

FIGURE 9, THRESHOLD VOLTAGE vs TEMPERATURE

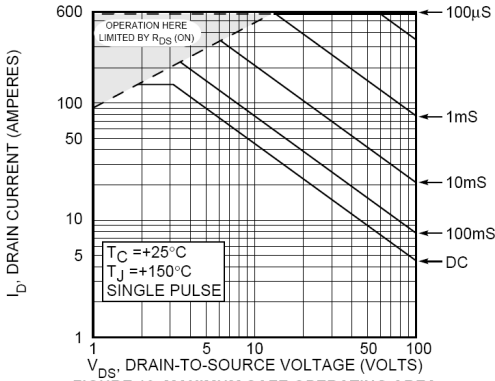

FIGURE 10, MAXIMUM SAFE OPERATING AREA

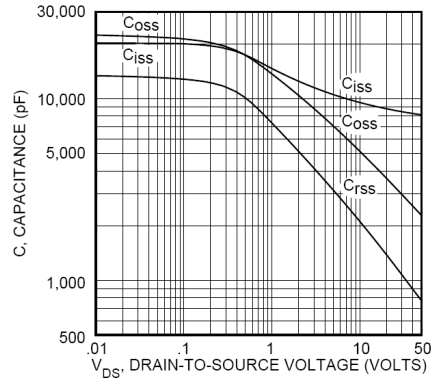

FIGURE 11, TYPICAL CAPACITANCE vs DRAIN-TO-SOURCE VOLTAGE

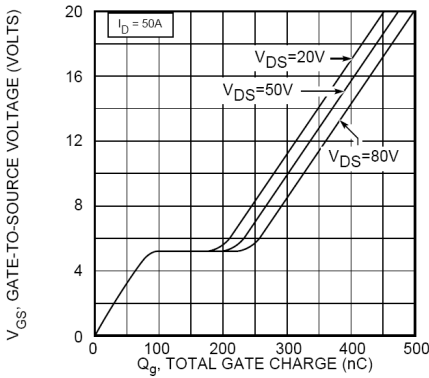

FIGURE 12, GATE CHARGES vs GATE-TO-SOURCE VOLTAGE

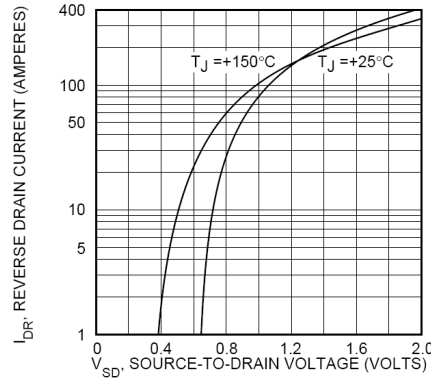

FIGURE 13, TYPICAL SOURCE-DRAIN DIODE FORWARD VOLTAGE

Typical Diode Performance Curve

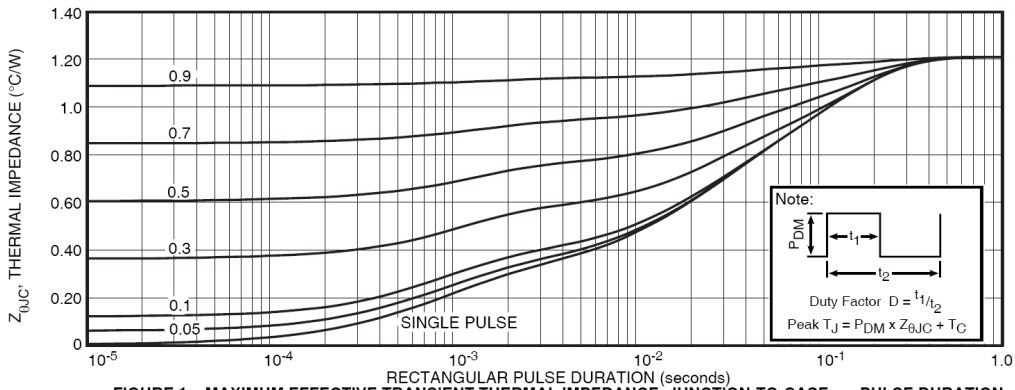

FIGURE 1a. MAXIMUM EFFECTIVE TRANSIENT THERMAL IMPEDANCE, JUNCTION-TO-CASE vs. PULSE DURATION

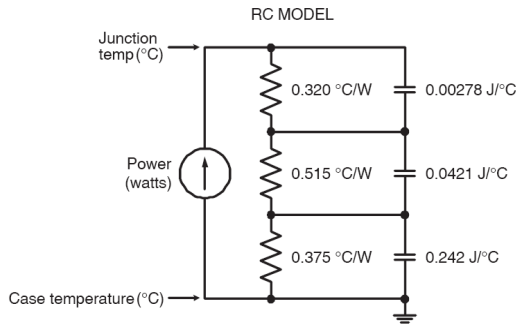

FIGURE 1b, TRANSIENT THERMAL IMPEDANCE MODEL

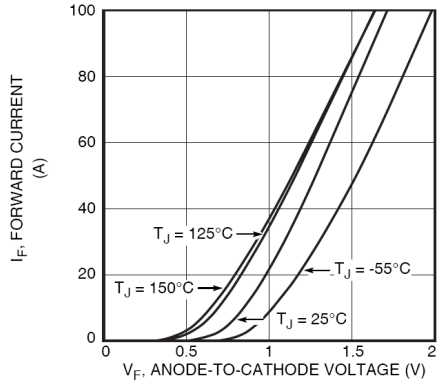

Figure 2. Forward Current vs. Forward Voltage

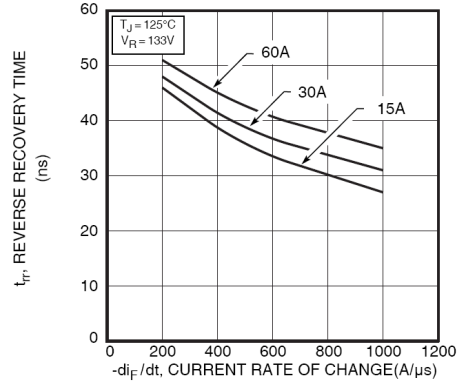

Figure 3. Reverse Recovery Time vs. Current Rate of Change

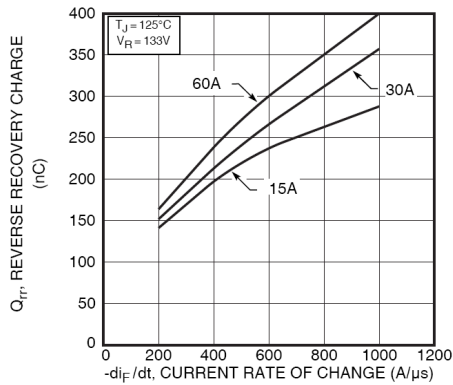

Figure 4. Reverse Recovery Charge vs. Current Rate of Change

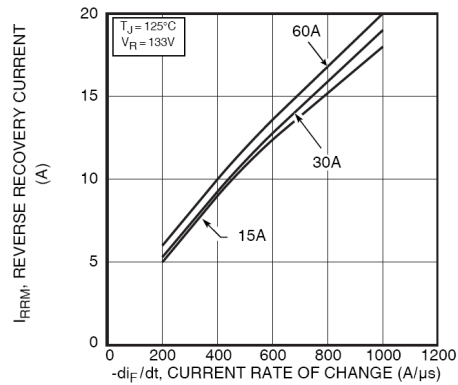

Figure 5. Reverse Recovery Current vs. Current Rate of Change

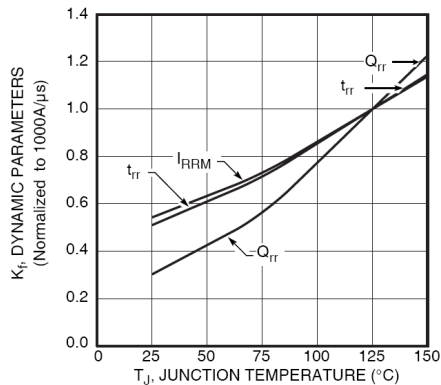

Figure 6. Dynamic Parameters vs. Junction Temperature

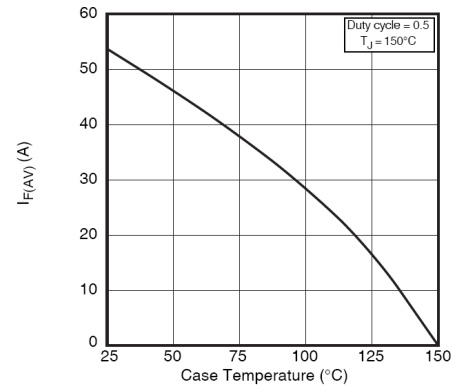

Figure 7. Maximum Average Forward Current vs. Case Temperature

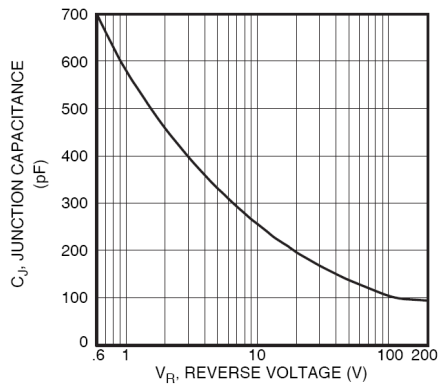

Figure 8. Junction Capacitance vs. Reverse Voltage

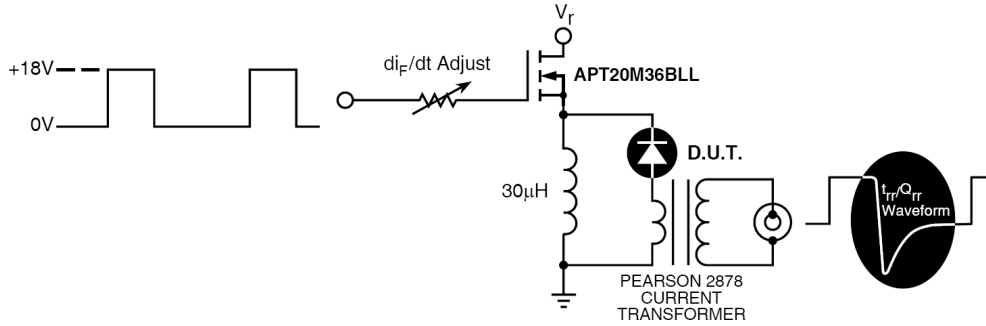

Figure 9. Diode Test Circuit

- 1 I_F - Forward Conduction Current
- 2 di_F/dt - Rate of Diode Current Change Through Zero Crossing.
- 3 I_{RRM} - Maximum Reverse Recovery Current.
- 4 t_{rr} - Reverse Recovery Time, measured from zero crossing where diode current goes from positive to negative, to the point at which the straight line through I_{RRM} and $0.25 \cdot I_{RRM}$ passes through zero.
- 5 Q_{rr} - Area Under the Curve Defined by I_{RRM} and t_{rr} .

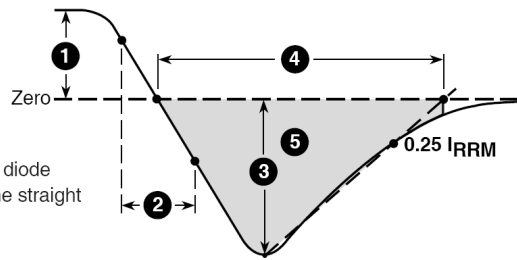
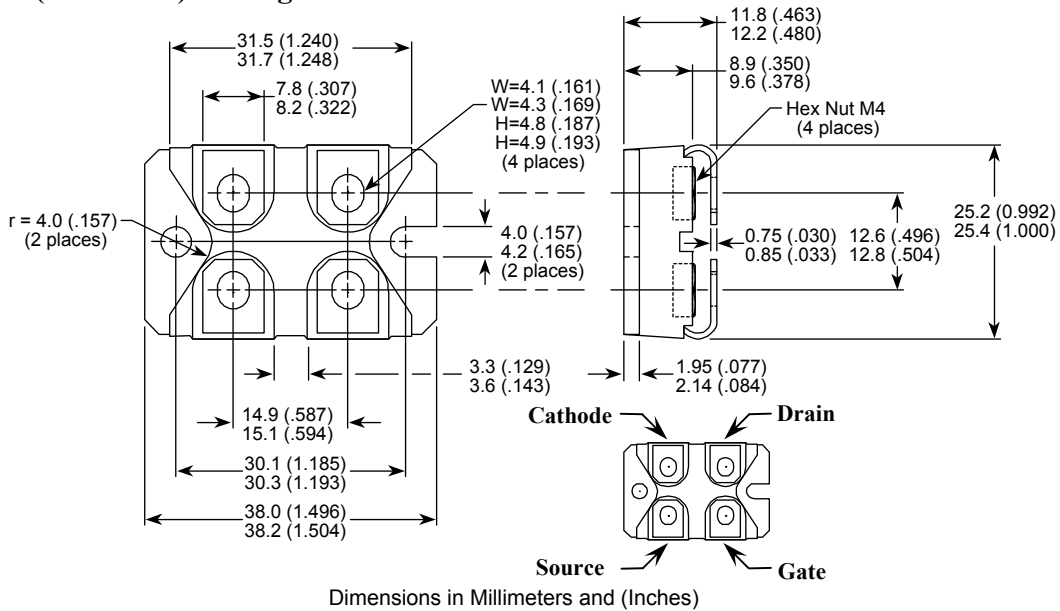

Figure 10. Diode Reverse Recovery Waveform and Definitions

SOT-227 (ISOTOP[®]) Package Outline



ISOTOP[®] is a registered trademark of ST Microelectronics NV

DISCLAIMER

The information contained in the document (unless it is publicly available on the Web without access restrictions) is PROPRIETARY AND CONFIDENTIAL information of Microsemi and cannot be copied, published, uploaded, posted, transmitted, distributed or disclosed or used without the express duly signed written consent of Microsemi. If the recipient of this document has entered into a disclosure agreement with Microsemi, then the terms of such Agreement will also apply. This document and the information contained herein may not be modified, by any person other than authorized personnel of Microsemi. No license under any patent, copyright, trade secret or other intellectual property right is granted to or conferred upon you by disclosure or delivery of the information, either expressly, by implication, inducement, estoppels or otherwise. Any license under such intellectual property rights must be approved by Microsemi in writing signed by an officer of Microsemi.

Microsemi reserves the right to change the configuration, functionality and performance of its products at anytime without any notice. This product has been subject to limited testing and should not be used in conjunction with life-support or other mission-critical equipment or applications. Microsemi assumes no liability whatsoever, and Microsemi disclaims any express or implied warranty, relating to sale and/or use of Microsemi products including liability or warranties relating to fitness for a particular purpose, merchantability, or infringement of any patent, copyright or other intellectual property right. Any performance specifications believed to be reliable but are not verified and customer or user must conduct and complete all performance and other testing of this product as well as any user or customers final application. User or customer shall not rely on any data and performance specifications or parameters provided by Microsemi. It is the customer's and user's responsibility to independently determine suitability of any Microsemi product and to test and verify the same. The information contained herein is provided "AS IS, WHERE IS" and with all faults, and the entire risk associated with such information is entirely with the User. Microsemi specifically disclaims any liability of any kind including for consequential, incidental and punitive damages as well as lost profit. The product is subject to other terms and conditions which can be located on the web at <http://www.microsemi.com/legal/tnc.asp>

Life Support Application

Seller's Products are not designed, intended, or authorized for use as components in systems intended for space, aviation, surgical implant into the body, in other applications intended to support or sustain life, or for any other application in which the failure of the Seller's Product could create a situation where personal injury, death or property damage or loss may occur (collectively "Life Support Applications").

Buyer agrees not to use Products in any Life Support Applications and to the extent it does it shall conduct extensive testing of the Product in such applications and further agrees to indemnify and hold Seller, and its officers, employees, subsidiaries, affiliates, agents, sales representatives and distributors harmless against all claims, costs, damages and expenses, and attorneys' fees and costs arising, directly or indirectly, out of any claims of personal injury, death, damage or otherwise associated with the use of the goods in Life Support Applications, even if such claim includes allegations that Seller was negligent regarding the design or manufacture of the goods.

Buyer must notify Seller in writing before using Seller's Products in Life Support Applications. Seller will study with Buyer alternative solutions to meet Buyer application specification based on Sellers sales conditions applicable for the new proposed specific part.