

Outline

Gearbox

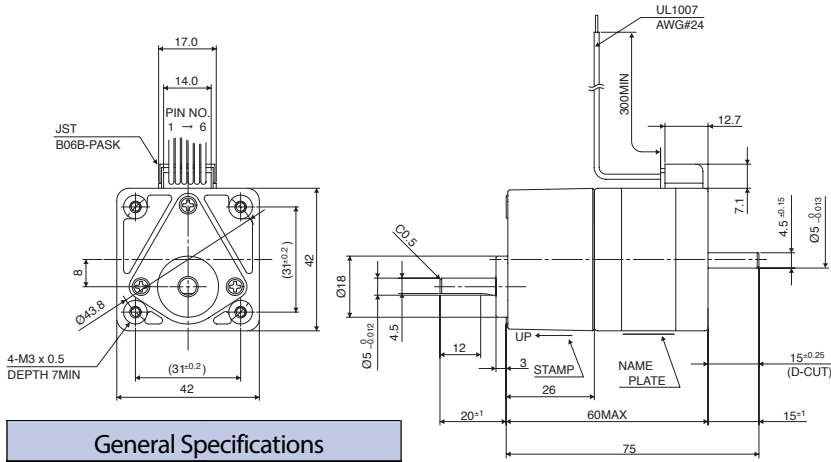

Hybrid

General Specifications

Temperature Rise: 80°C MAX
 Ambient Temperature Range: -10 °C ~ +50°C
 Insulation Resistance: 100MΩ MIN. DC500V
 Dielectric Strength: AC500V 1min
 Permissible Radial Load(at 10mm from shaft end): 20N (2kgf)
 Permissible Thrust Load: 15N (1.5kgf)

PIN NO. vs. PHASE

PHASE	A	A COM	\bar{A}	B	B COM	\bar{B}
PIN NO.	3	2	1	4	5	6

Specifications

Model	Rated Current (A)	Resistance (Ohms)	Step Angle (deg)	Gear Ratio (1 : X)	Permissible Torque (Nm (kgf · cm))	Permissible Speed Range (r/min)	Backlash (min(deg))	Mass (g)
GS0036-17M001	0.85	4.2	0.5	1 : 3.6	0.2 (2.04)	0 ~ 500	2° & under	310
GS0072-17M001	0.85	4.2	0.25	1 : 7.2	0.4 (4.08)	0 ~ 250	2° & under	310
GS0090-17M001	0.85	4.2	0.2	1 : 9	0.5 (5.10)	0 ~ 200	2° & under	310
GS0100-17M001	0.85	4.2	0.18	1 : 10	0.56 (5.71)	0 ~ 180	2° & under	310
GS0180-17M001	0.85	4.2	0.1	1 : 18	0.8 (8.06)	0 ~ 100	2° & under	320
GS0360-17M001	0.85	4.2	0.05	1 : 36	0.8 (8.06)	0 ~ 50	2° & under	320
GS0500-17M001	0.85	4.2	0.036	1 : 50	0.8 (8.06)	0 ~ 36	2° & under	330
GS1000-17M001	0.85	4.2	0.018	1 : 100	0.8 (8.06)	0 ~ 18	2° & under	330

*Drive Sequence: Unipolar

*Leadwires will be supplied with the motor

*Direction of rotation of the motor and that of the gear output shaft are the same for the gear ratios 1:3.6, 1:7.2, 1:9, 1:10, 1:50, 1:100. It is the opposite for 1:18 and 1:36 gear ratio

Specifications

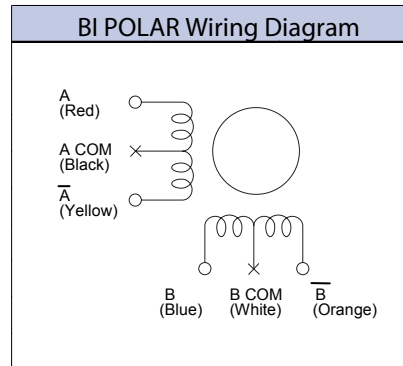
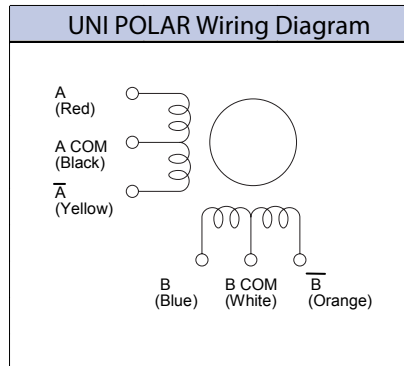

*Do not connect A COM and B COM. Please insulate individually.
*Apply 70% of Unipolar rated current.

Torque/Speed Characteristics

Model No.: GS0036-17M001
Supply Voltage: 24 V (DC)
Current: 0.85A/Phase
Step Angle: 0.5°/step

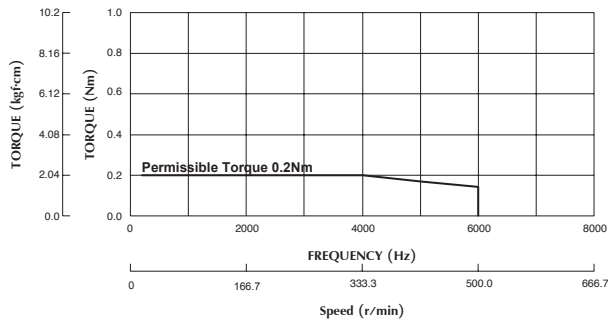

Model No.: GS0072-17M001
Supply Voltage: 24 V (DC)
Current: 0.85A/Phase
Step Angle: 0.25°/step

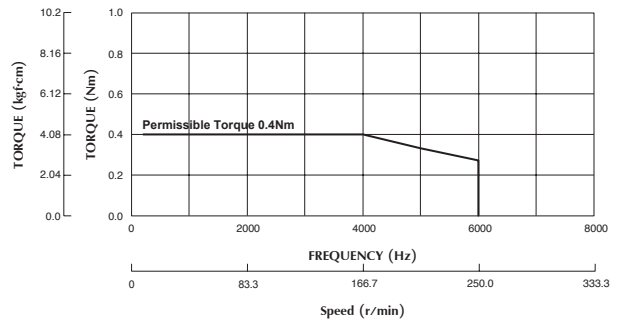

Model No.: GS0090-17M001
Supply Voltage: 24 V (DC)
Current: 0.85A/Phase
Step Angle: 0.2°/step

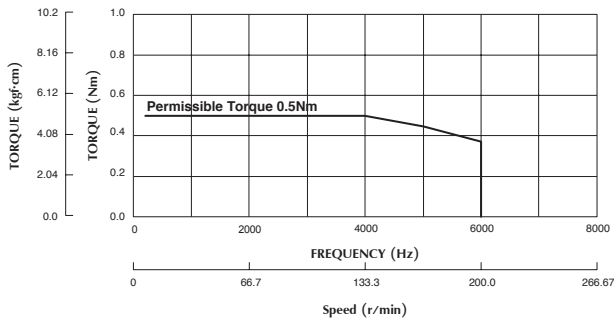

Model No.: GS0040-17M001
Supply Voltage: 24 V (DC)
Current: 0.85A/Phase
Step Angle: 0.7°/step

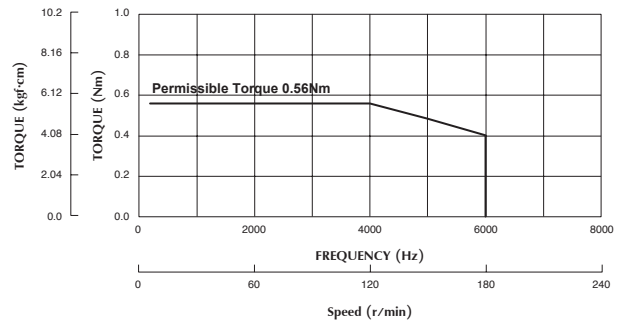

Torque/Speed Characteristics

Model No.: GS0180-17M001
 Supply Voltage: 24 V (DC)
 Current: 0.85A/Phase
 Step Angle: 0.1°/step

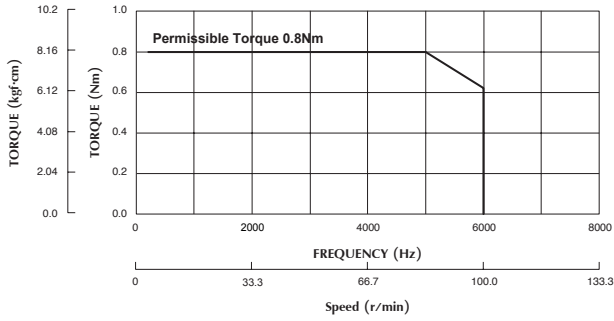

Model No.: GS0360-17M001
 Supply Voltage: 24 V (DC)
 Current: 0.85A/Phase
 Step Angle: 0.05°/step

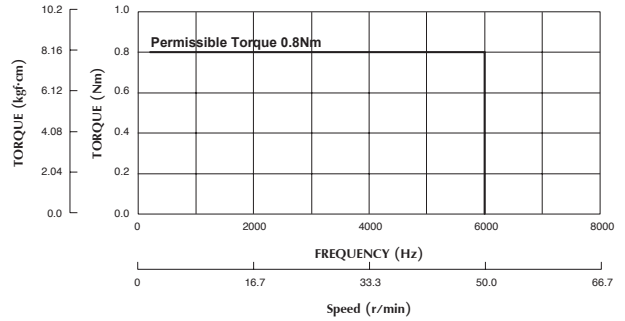

Model No.: GS0500-17M001
 Supply Voltage: 24 V (DC)
 Current: 0.85A/Phase
 Step Angle: 0.036°/step

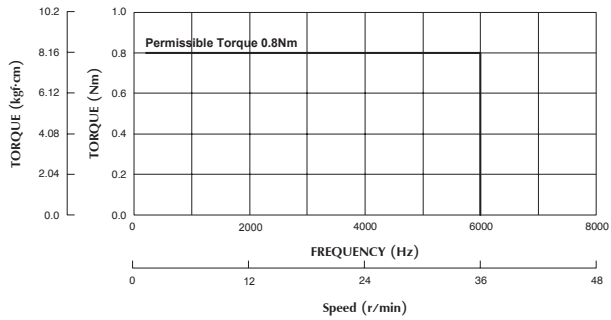

Model No.: GS1000-17M001
 Supply Voltage: 24 V (DC)
 Current: 0.85A/Phase
 Step Angle: 0.018°/step

