

ESD protection  
EMI filter  
Level shifter and buffer

# Interface protection products selection guide

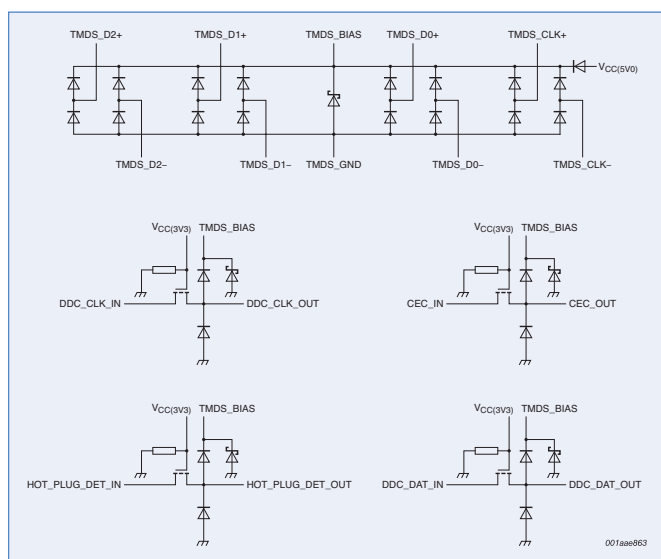

ESD protection for HDMI transceivers with integrated level shifter IP4776CZ38

## Portfolio key features

- ▶ Level shifting, buffering, ESD protection, termination, pull-up resistors, EMI filtering
- ▶ Superior size / performance ratio
- ▶ Fully integrated passive and active components
- ▶ Lowest line capacitance for high-speed interfaces,  $C_{line} = 1.0 \text{ pF}$
- ▶ High-level ESD protection in compliance with IEC 61000-4-2, level 4
- ▶ Lead-free products

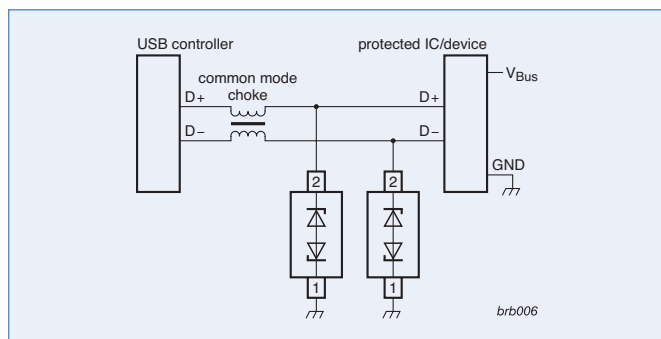

USB2.0 protection with PESD5V0U1BL in SOD882

## Rail-to-Rail ESD protection diodes, ultra low capacitance < 5 pF

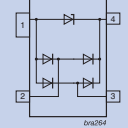
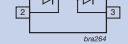
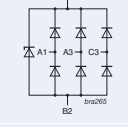
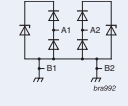
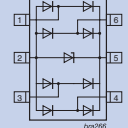
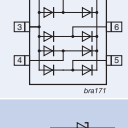
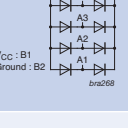
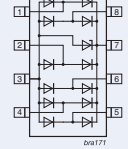
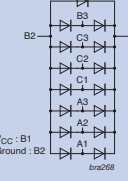
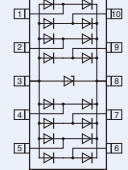
Number of protected lines	$I_R @ V_R$		$C_{line}$ typ (pF)	ESD rating* max (kV)	Configuration	Type	Package	Size (mm)
	max (μA)	(V)						
2	0.1	3	1	8		PRTR5V0U2X	SOT143B	2.9 x 1.3 x 1.0
	0.1	3	1.8	12		<b>PRTR5V0U2AX</b>		
3	0.1	3	4	8		IP4059CX5/LF	5 ball CSP	1.34 x 0.96 x 0.65
	0.1	3	1.3	15		<b>IP4359CX4/LF</b>	4 ball CSP	0.76 x 0.76 x 0.65
4	0.1	3	1	8		<b>PRTR5V0U4Y</b>	SOT363 (SC-88)	2.0 x 1.25 x 0.95
						PRTR5V0U4D	SOT457 (SC-74)	2.9 x 1.5 x 1.0
						<b>IP4221CZ6-S</b>	SOT886 (XSON6)	1.45 x 1.0 x 0.5
	1.0	3	0.7	8		IP4280CZ10	SOT552 (TSSOP10)	3.0 x 3.0 x 1.1
6	0.1	3	1	8		PRTR5V0U6S	SOT96 (SO8)	4.9 x 3.9 x 1.75
	0.1	3	1	8		PRTR5V0U6AS		
7	0.1	3	4	8		IP4067CX9/LF	9 ball CSP	1.52 x 1.46 x 0.65
8	0.1	3	1	8		PRTR5V0U8S	SOT552 (TSSOP10)	3.0 x 3.0 x 1.1

\* acc. to IEC 61000-4-2 (contact discharge)

types in **bold red** represent new products

## ESD protection diodes, very low capacitance < 25 pF

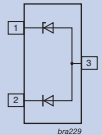
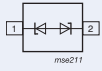
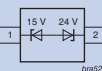
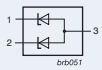
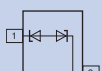
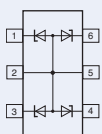
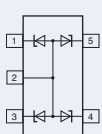
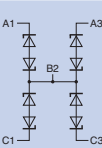
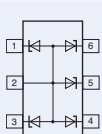
Number of protected lines uni- bi- directional		$I_{RM}$ @ max ( $\mu$ A)	$V_{RWM}$ (V)	$C_{line}$ typ (pF)	$P_{PP}^*$ max (W)	ESD rating** max (kV)	Configuration	Type	Package	Size (mm)
1		2	3.3	0.6	80	30		PESD3V3U1UT	SOT23	2.9 x 1.3 x 1.0
		1	5	0.6	80	30		PESD5V0U1UT		
		0.05	12	0.6	200	30		PESD12VU1UT		
		0.05	15	0.6	200	30		PESD15VU1UT		
		0.05	24	0.6	200	23		PESD24VU1UT		
	1	0.1	5	2.9	25	10		<b>PESD5V0U1BA</b>	SOD323 (SC-76)	1.7 x 1.25 x 0.95
		0.1	5	2.9	25	10		<b>PESD5V0U1BB</b>	SOD523 (SC-79)	1.2 x 0.8 x 0.6
		0.1	5	2.9	25	10		<b>PESD5V0U1BL</b>	SOD882	1.0 x 0.6 x 0.5
	1	0.05	15 (diode 1) 24 (diode 2)	13	160	23		PESD1LIN	SOD323 (SC-76)	1.7 x 1.25 x 0.95
2	1	0.3	3.3	22	30	15		PESD3V3L2UM	SOT883 (SC-101)	1.0 x 0.6 x 0.5
		0.025	5	16	30	15		PESD5V0L2UM		
	2	0.1	5	2.8	25	10		<b>PESD5V0U2BT</b>	SOT23	2.9 x 1.3 x 1.0
		0.05	24	11	200	23		PESD1CAN		
		0.01	24	25	230	30		<b>PESD2CAN</b>		
		0.05	24	11 ***	200	23		<b>PESD1FLEX</b>		
4	3	0.3	3.3	22	30	20		<b><i>PESD3V3L4UF</i></b>	SOT886 (XSON6)	1.45 x 1.0 x 0.5
		0.025	5	16	30	20		<b><i>PESD5V0L4UF</i></b>		
		0.3	3.3	15	16	10		<b><i>PESD3V3V4UF</i></b>		
		0.025	5	12	16	10		<b><i>PESD5V0V4UF</i></b>		
		0.3	3.3	22	30	20		PESD3V3L4UG	SOT353 (SC-88A)	2.0 x 1.25 x 0.95
		0.025	5	16	30	20		PESD5V0L4UG		
		0.3	3.3	15	16	10		PESD3V3V4UG		
		0.025	5	12	16	10		PESD5V0V4UG	SOT665	1.6 x 1.2 x 0.55
		0.3	3.3	22	30	20		PESD3V3L4UW		
		0.025	5	16	30	20		PESD5V0L4UW		
0.3	3.3	15	16	10	PESD3V3V4UW					
0.025	5	12	16	10	PESD5V0V4UW					
	4	0.01	5	16	-	8		IP4043CX5/LF	5 ball CSP	1.12 x 1.12 x 0.65
5	4	0.3	3.3	22	25	20		<b><i>PESD3V3L5UF</i></b>	SOT886 (XSON6)	1.45 x 1.0 x 0.5
		0.025	5	16	25	20		<b><i>PESD5V0L5UF</i></b>		
		0.3	3.3	22	25	20		PESD3V3L5UY	SOT363 (SC-88)	2.0 x 1.25 x 0.95
		0.025	5	16	25	20		PESD5V0L5UY		
		0.3	3.3	22	25	20		PESD3V3L5UV	SOT666	1.6 x 1.2 x 0.55
		0.025	5	16	25	20		PESD5V0L5UV		

types in **bold red** represent new products  
types in **bold red italic underlined** represent products in development

## ESD protection diodes, very low capacitance < 25 pF (continued)

Number of protected lines uni- bi- directional		$I_{RM}$ @ $V_{RWM}$ max (µA) (V)	$C_{line}$ typ (pF)	$P_{PP}^*$ max (W)	ESD rating** max (kV)	Configuration	Type	Package	Size (mm)	
6	5	0.025	5	16	35	20		PESD5V0L6US	SOT96 (SO8)	4.9 x 3.9 x 1.75
		0.025	5	16	35	20		PESD5V0L6UAS	SOT505 (TSSOP8)	3.0 x 3.0 x 1.1
	7	0.025	5	7	35	20		PESD5V0L7BS	SOT96 (SO8)	4.9 x 3.9 x 1.75
								PESD5V0L7BAS	SOT505 (TSSOP8)	3.0 x 3.0 x 1.1
16	15	0.01	3	15	-	15		IP4080CX20/LF	WLCSP	2.51 x 2.01 x 0.65

\* 8/20 µs surge pulse acc. to IEC 61000-4-5

\*\* acc. to IEC 61000-4-2 (contact discharge)

\*\*\*  $f = 5$  MHz;  $V_R = 0$  V

## ESD protection diodes, standard capacitance

Number of protected lines uni- bi- directional		$I_{RM}$ @ $V_{RWM}$ max (µA) (V)	$C_{line}$ typ (pF)	$P_{PP}^*$ max (W)	ESD rating** max (kV)	Configuration	Type	Package	Size (mm)	
1		2	3.3	200	150	30		PESD3V3S1UL	SOD882	1.0 x 0.6 x 0.5
		1	5	150	150	30		PESD5V0S1UL		
		0.05	12	38	150	30		PESD12VS1UL		
		0.05	15	32	150	30		PESD15VS1UL		
		0.05	24	23	150	23		PESD24VS1UL		
		0.05	24	23	160	23		PESD24VS1UB		
		2	3.3	207	330	30		PESD3V3S1UB	SOD523 (SC-79)	1.2 x 0.8 x 0.6
		1	5	152	260	30		PESD5V0S1UB		
		0.05	12	38	180	30		PESD12VS1UB		
		0.05	15	32	160	30		PESD15VS1UB		
		0.05	24	23	160	23		PESD24VS1UB		
		6	2.5	229	260	30		<b>PESD5Z2.5</b>		
		0.05	3.3	172	260	30		<b>PESD5Z3.3</b>		
		0.05	5	89	180	30		<b>PESD5Z5.0</b>		
		0.01	6	78	180	30		<b>PESD5Z6.0</b>		
		0.01	7	69	180	30		<b>PESD5Z7.0</b>		
0.01	12	35	200	30	<b>PESD5Z12</b>					
1		0.1	5	35	120	30		PESD5V0S1BA	SOD323 (SC-76)	1.7 x 1.25 x 0.95
								PESD5V0S1BB	SOD523 (SC-79)	1.2 x 0.8 x 0.6
								PESD5V0S1BL	SOD882	1.0 x 0.6 x 0.5
		2	3.3	101	500	30		PESD3V3L1BA	SOD323 (SC-76)	1.7 x 1.25 x 0.95
		1	5	75	500	30		PESD5V0L1BA		
		0.05	12	19	200	30		PESD12VL1BA		
		0.05	15	16	200	30		PESD15VL1BA		
		0.05	24	11	200	23		PESD24VL1BA		

types in **bold red** represent new products

## ESD protection diodes, standard capacitance (continued)

Number of protected lines uni- bi- directional		$I_{RM}$ @ $V_{RWM}$ max (µA) (V)	$C_{line}$ typ (pF)	$P_{PP}^*$ max (W)	ESD rating** max (kV)	Configuration	Type	Package	Size (mm)			
2	1	2	3.3	207	330	30		PESD3V3S2UAT	SOT23	2.9 x 1.3 x 1.0		
		1	5	152	260	30		PESD5V0S2UAT				
		0.05	12	38	180	30		PESD12VS2UAT				
		0.05	15	32	160	30		PESD15VS2UAT				
		0.05	24	23	160	23		PESD24VS2UAT				
		3	3.3	200	150	30		PESD3V3S2UQ			SOT663	1.6 x 1.2 x 0.55
		0.3	5	150	150	30	PESD5V0S2UQ					
		0.03	12	38	150	30	PESD12VS2UQ					
		0.05	15	32	150	30	PESD15VS2UQ					
		0.05	24	23	150	23	PESD24VS2UQ					
		2	3.3	207	330	30	PESD3V3S2UT	SOT23	2.9 x 1.3 x 1.0			
		1	5.25	152	260	30	PESD5V2S2UT					
		1	12	38	180	30	PESD12VS2UT					
		1	15	32	160	30	PESD15VS2UT					
1	24	23	160	23	PESD24VS2UT							
2	2	0.1	5	35	120	30				PESD5V0S2BT	SOT23	2.9 x 1.3 x 1.0
		2	3.3	101	350	30		PESD3V3L2BT				
		1	5	75	350	30		PESD5V0L2BT				
		0.05	12	19	200	30		PESD12VL2BT				
		0.05	15	16	200	30		PESD15VL2BT				
		0.05	24	11	200	23		PESD24VL2BT				
		4	3	0.8	3.3	215		200	30			
0.2	5			165	200	30	<b><u>PESD5V0S4UF</u></b>					
2	3			200	-	8	BZA456A					
0.7	4			165	-	8	BZA462A					
0.075	14			37	-	8	BZA418A					
0.1	15			37	-	8	BZA420A					
0.8	3.3			215	200	30	<b><u>PESD3V3S4UD</u></b>	SOT457 (SC-74)	2.9 x 1.5 x 1.0			
0.2	5			165	200	30	<b><u>PESD5V0S4UD</u></b>					
0.01	12			73	200	30	<b><u>PESD12VS4UD</u></b>					
0.01	15			60	200	30	<b><u>PESD15VS4UD</u></b>					
0.01	24		45	200	23	<b><u>PESD24VS4UD</u></b>						
2	3		200	-	8	BZA856A						
0.7	4		165	-	8	BZA862A						
0.2	4.3		145	-	8	BZA868A						
0.01	15		37	-	8	BZA820A						
1	3		107	-	8	BZA856AL						
0.5	4		90	-	8	BZA862AL						
0.01	4.3		78	-	8	BZA868AL						
1	3		107	-	8	BZA956A	SOT665	1.6 x 1.2 x 0.55				
0.5	4		90	-	8	BZA962A						
0.01	4.3	78	-	8	BZA968A							
0.01	3.3	30	-	15		IP4042CX5/LF	5 ball CSP	1.34 x 0.94 x 0.65				
5	4	0.8	3.3	215	200	30		BZA408B	SOT457 (SC-74)	2.9 x 1.5 x 1.0		
		0.2	5	165	200	30		<b><u>PESD3V3S5UD</u></b>				
		0.01	12	73	200	30		<b><u>PESD5V0S5UD</u></b>				
		0.01	15	60	200	30		<b><u>PESD12VS5UD</u></b>				
		0.01	24	45	200	23		<b><u>PESD15VS5UD</u></b>				
18	17	1	5.2	100	100	8		BZA100	SOT163 (SO20)	12.8 x 7.5 x 2.65		
								PESD5V2S18U	SOT339 (SSOP20)	7.2 x 5.3 x 2.0		

\* 8/20 µs surge pulse acc. to IEC 61000-4-5  
 \*\* acc. to IEC 61000-4-2 (contact discharge)

types in **bold red** represent new products  
 types in **bold red italic underlined** represent products in development

## EMI filter and ESD protection

Baseband interface	Number of protected lines	Line small-signal equivalents		Digital interface clock speed	Remark	Type	Package	Size (mm)
		R <sub>line</sub>	C <sub>line</sub>					
Reverse battery	1	-	240 pF	-	overvoltage and reverse battery protection	<b>IP4085CX4/LF</b>	4 ball CSP	0.91 x 0.91 x 0.65
		-	450 pF	-	overvoltage and reverse battery protection	<b>IP4385CX4/LF</b>	4 ball CSP	0.76 x 0.76 x 0.61
Audio	2	0.9 Ω	290 pF	-	low-ohmic speaker (< ~8 Ω)	IP4047CX6/LF	6 ball CSP	1.56 x 1.01 x 0.65
		10 Ω	200 pF	-	high-ohmic speaker (> ~8 Ω)	IP4048CX5/LF	5 ball CSP	0.91 x 1.28 x 0.65
		68 Ω	110 pF	-	single-ended or differential microphone	IP4049CX5/LF	5 ball CSP	0.91 x 1.28 x 0.65
		470 Ω	35 pF	-	single-ended or differential microphone	IP4055CX6/LF	6 ball CSP	1.56 x 1.03 x 0.65
		470 Ω	< 20 pF	-	single-ended or differential microphone	<b>IP4355CX6/LF</b>	6 ball CSP	1.16 x 0.76 x 0.65
		50 Ω / 2200 Ω	2000 pF	-	single-ended to quasi-differential microphone channel with integrated biasing network	<b>IP5002CX8/LF</b>	8 ball CSP	1.67 x 1.67 x 0.65
	50 Ω	4000 pF	-	differential microphone filter with integrated biasing network for ΣΔ ADC converters	<b>IP5006CX11/LF</b>	11 ball CSP	1.41 x 1.91 x 0.65	
	5	15 Ω / 95 Ω	65 pF / 33 pF	-	single-ended microphone and high-ohmic speaker (> ~8 Ω) with integrated 2 kΩ pull-up resistor	<b>IP4363CX10/LF</b>	10 ball CSP	0.76 x 1.96 x 0.61
6	40 Ω / 1450 Ω / 10 Ω	55 pF / 20 pF / 200 pF	-	fully integrated audio interface protection for differential microphone and differential speaker, including EMI filtering and pull up resistors	IP4027CX20/LF	20 ball CSP	1.91 x 2.52 x 0.65	
	50 Ω / 10 Ω	50 pF / 100 pF / 1000 pF	-	fully integrated audio interface protection for differential microphone and differential speaker, including EMI filtering and pull up resistors	<b>IP4125CX20/LF</b>	20 ball CSP	2.00 x 2.66 x 0.65	
USB	2	33 Ω / 1.3 kΩ	30 pF	~5.5 MHz	fully integrated USB2.0 low / full-speed interface with EMI filter, ESD protection, pull-up resistors and impedance matching	IP4056CX8/LF	8 ball CSP	1.27 x 1.83 x 0.65
		33 Ω / 1.3 kΩ / 10 kΩ	30 pF	~5.5 MHz	fully integrated USB2.0 low / full-speed interface with EMI filter, ESD protection, pull-up resistors and impedance matching	IP4057CX10/LF	10 ball CSP	1.56 x 1.91 x 0.65
		33 Ω / 1.3 kΩ / 17 kΩ / 15 kΩ	27 pF	~5.5 MHz	fully integrated USB2.0 low / full-speed interface with EMI filter, ESD protection, pull-up resistors and impedance matching	IP4065CX11/LF	11 ball CSP	1.47 x 1.97 x 0.65
		33 Ω / 1.5 kΩ	35 pF	~5.5 MHz	fully integrated USB2.0 low / full-speed interface with EMI filter, ESD protection, pull-up resistors and impedance matching on NXP ISP110x, ISP130x, ISP136x	IP4058CX8/LF	8 ball CSP	0.91 x 1.91 x 0.65
		17 Ω / 1.5 kΩ	35 pF	~5.5 MHz	fully integrated USB2.0 low / full-speed interface with EMI filter, ESD protection, pull-up resistors and impedance matching on NXP ISP110x, ISP130x, ISP136x	<b>IP4158CX8/LF</b>	8 ball CSP	0.91 x 1.91 x 0.65
		33 Ω	35 pF	~5.5 MHz	fully integrated USB1.0 low / full-speed interface with EMI filter, ESD protection and impedance matching on NXP ISP1110	IP4078CX6/LF	6 ball CSP	0.91 x 1.41 x 0.65
		-	1.4 pF	~1 GHz	USB2.0 high-speed ESD protection on NXP ISP1504/01 HS transceiver	<b>IP4359CX4/LF</b>	4 ball CSP	0.76 x 0.76 x 0.61
	3	-	3 pF	~240 MHz	USB2.0 high-speed ESD protection on NXP ISP176x and ISP1504	IP4059CX5/LF	5 ball CSP	0.96 x 1.34 x 0.65
		-	1.0 pF	~240 MHz	USB2.0 high-speed ESD protection on NXP ISP1504/01 HS transceiver	IP4221CZ6-S	SOT886	1.45 x 1.0 x 0.5
	SIM card	3	47 Ω / 100 Ω	35 pF	~12 MHz	EMI filter, ESD protection	IP4044CX8/LF	8 ball CSP
47 Ω / 100 Ω			< 20 pF	~20 MHz	EMI filter, ESD protection	IP4064CX8/LF	8 ball CSP	1.41 x 1.41 x 0.65
47 Ω / 100 Ω			< 20 pF	~20 MHz	EMI filter, ESD protection, extremely small size	<b>IP4364CX8/LF</b>	8 ball CSP	1.16 x 1.16 x 0.61
-			1 pF	~240 MHz	ESD protection	IP4221CZ6-S	SOT886 (XSON6)	1.45 x 1.0 x 0.5

types in **bold red** represent new products

## EMI filter and ESD protection (continued)

Baseband interface	Number of protected lines	Line small-signal equivalents		Digital interface clock speed	Remark	Type	Package	Size (mm)	
		R <sub>line</sub>	C <sub>line</sub>						
Memory cards	4	47 Ω / 13 kΩ / 56 kΩ	25 pF	-	MMC ESD protection, pull-up resistors	IP4051CX11/LF	11 ball CSP	1.44 x 1.96 x 0.65	
		50 Ω / 75 kΩ / 7 kΩ	18 pF	~25 MHz	high-speed MMC ESD protection, pull-up resistors	IP4060CX16/LF	16 ball CSP	1.96 x 1.97 x 0.65	
	7	40 Ω / 50 kΩ / 25 kΩ	18 pF	~20 MHz	(mini) SD/trans flash-card ESD protection, EMI filter, pull-up resistors	IP4052CX20/LF	20 ball CSP	2.54 x 1.96 x 0.65	
		-	5 pF	~24 MHz	memory stick PRO ESD protection	IP4067CX9/LF	9 ball CSP	1.46 x 1.52 x 0.65	
	9	40 Ω / 50 kΩ / 15 kΩ	20 pF	> 52 MHz	(mini) SD card/trans flash ESD protection, EMI filter, pull-up resistor	<b><u>IP4352CX24/LF</u></b>	24 ball CSP	2.02 x 2.01 x 0.61	
		-	-	> 52 MHz	(mini) SD/SDIO memory cardlevel shifter, can be combined with IP4352CX24/LF	<b><u>IP4852CX24/LF</u></b>	24 ball CSP	2.01 x 2.01 x 0.61	
		-	-	> 52 MHz	(mini) SD/SDIO memory cardlevel shifter and voltage regulator, incl. ESD and EMI filter	<b><u>IP4853CX24/LF</u></b>	24 ball CSP	2.01 x 2.01 x 0.61	
Multi-channel filters e.g.:	4	100 Ω	45 pF	~30 MHz	EMI filter, ESD protection	<b><u>IP4254CZ8</u></b>	8 pin QFN	1.7 x 1.35 x 0.5	
	6	100 Ω	45 pF	~30 MHz	EMI filter, ESD protection	<b><u>IP4254CZ12</u></b>	12 pin QFN	2.5 x 1.35 x 0.5	
	8	100 Ω	45 pF	~30 MHz	EMI filter, ESD protection	<b><u>IP4254CZ16</u></b>	16 pin QFN	3.3 x 1.35 x 0.5	
	4	200 Ω	45 pF	~30 MHz	EMI filter, ESD protection	<b><u>IP4253CZ8</u></b>	8 pin QFN	1.7 x 1.35 x 0.5	
	6	200 Ω	45 pF	~30 MHz	EMI filter, ESD protection	<b><u>IP4253CZ12</u></b>	12 pin QFN	2.5 x 1.35 x 0.5	
	8	200 Ω	45 pF	~30 MHz	EMI filter, ESD protection	<b><u>IP4253CZ16</u></b>	16 pin QFN	3.3 x 1.35 x 0.5	
	Bottom connector	6	100 Ω	60 pF	~20 MHz	EMI filter, ESD protection	IP4053CX15/LF	15 ball CSP	2.98 x 1.33 x 0.65
		8	100 Ω	50 pF	~25 MHz	EMI filter, ESD protection	IP4088CX20/LF	20 ball CSP	3.91 x 1.28 x 0.65
6		100 Ω	30 pF	~40 MHz	EMI filter, ESD protection	<b><u>IP4153CX15/LF</u></b>	15 ball CSP	2.91 x 1.28 x 0.65	
LCD display	10	80 Ω	40 pF	~30 MHz	EMI filter, ESD protection	IP4032CX25/LF	25 ball CSP	2.41 x 2.41 x 0.65	
		80 Ω	40 pF	~30 MHz	EMI filter, ESD protection (higher tolerances as IP4032CX25/LF)	IP4033CX25/LF	25 ball CSP	2.41 x 2.41 x 0.65	
		84 Ω	14 pF	~40 MHz	EMI filter, ESD protection	IP4040CX25/LF	25 ball CSP	2.41 x 2.46 x 0.65	
		200 Ω	50 pF	~20 MHz	EMI filter, ESD protection	IP4041CX25/LF	25 ball CSP	2.41 x 2.41 x 0.65	
Camera interface	10	1 kΩ	50 pF	< 1 MHz	EMI filter, ESD protection	IP4035CX24/LF	24 ball CSP	2.46 x 2.44 x 0.65	
		200 Ω	50 pF	~20 MHz	EMI filter, ESD protection, extremely small size	<b><u>IP4341CX25/LF</u></b>	25 ball CSP	2.01 x 2.01 x 0.61	
Keypad connector	7	70 Ω	25 pF	~40 MHz	EMI filter, ESD protection, extremely small size	<b><u>IP4337CX18/LF</u></b>	18 ball CSP	1.96 x 1.61 x 0.61	
	10	70 Ω	25 pF	~40 MHz	EMI filter, ESD protection, extremely small size	<b><u>IP4338CX24/LF</u></b>	24 ball CSP	1.96 x 2.01 x 0.61	
	1	75 Ω	36 pF	-	EMI filter, ESD protection with common ground	<b><u>IP4307CX4/LF</u></b>	4 ball CSP	0.76 x 0.76 x 0.61	
Generic ESD protection	4	-	30 pF	~30 MHz	4x single diode with one common ground	IP4042CX5/LF	5 ball CSP	0.94 x 1.34 x 0.65	
		-	14 pF	~40 MHz	4x single diode with one common ground	<b><u>IP4142CX5/LF</u></b>	5 ball CSP	0.91 x 1.28 x 0.65	
		-	16 pF	~40 MHz	4x back-to-back diode with one common ground	IP4043CX5/LF	5 ball CSP	1.12 x 1.12 x 0.65	
		-	16 pF	~40 MHz	4x back-to-back diode with one common ground, extremely small size	<b><u>IP4343CX5/LF</u></b>	5 ball CSP	0.93 x 0.93 x 0.61	
	2	-	10 pF	~40 MHz	2x back-to-back diode with one common ground, extremely small size	<b><u>IP4303CX4/LF</u></b>	4 ball CSP	0.76 x 0.26 x 0.61	
	1	-	10 pF	~40 MHz	1x back-to-back diode with one common ground, extremely small size	<b><u>IP4302CX2/LF</u></b>	2 ball CSP	0.52 x 0.7 x 0.61	

types in **bold red** represent new products  
types in **bold red italic underlined** represent products in development

## Level shifter, buffer and EMI filter for consumer and computing

Interface	Number of protected lines	Buffer	Level shifter	C <sub>line</sub>	Resistor	Remark	Type	Package	Size (mm)
VGA	7	yes	yes	5 pF	55 Ω	sync buffer, DDC level shifter	IP4770CZ16	SOT519 (SSOP16)	4.9 x 3.9 x 1.73
		yes	yes	5 pF	65 Ω	sync buffer, DDC level shifter	IP4771CZ16		
		yes	yes	5 pF	10 Ω	sync buffer, DDC level shifter	IP4772CZ16		
IEEE1394	4	-	-	5 pF	55 Ω	common mode filter	IP4224CZ6	SOT457 (SC-74)	2.9 x 1.5 x 1.0
LVDS	10	-	-	5 pF	100 Ω	100 Ω termination	IP4263CZ14	SOT108 (SO14)	8.65 x 3.9 x 1.75
USB	2	-	-	1 pF	-	ESD protection	PRTR5V0U2X	SOT143B	2.9 x 1.3 x 1.0
	4	-	-	1 pF	-	ESD protection	<b>IP4220CZ6</b>	SOT457 (SC-74)	2.9 x 1.5 x 1.0
		-	-	1 pF	-	ESD protection, as IP4220CZ6 but different bonding	PRTR5V0U4AD	SOT457 (SC-74)	2.9 x 1.5 x 1.0
		-	-	1 pF	-	ESD protection, as IP4220CZ6 but higher tolerances	<b>IP4223CZ6</b>	SOT457 (SC-74)	2.9 x 1.5 x 1.0
		-	-	1 pF	-	USB2.0 high-speed SD card, SIM card	<b>IP4221CZ6-S</b>	SOT886 (XSON6)	1.45 x 1.0 x 0.5
		-	-	1 pF	-	USB2.0 high-speed SD card, SIM card	<b>IP4221CZ6-XS</b>	SOT891 (XSON6)	1.0 x 1.0 x 0.5
		-	-	3 pF	1 Ω	> 15 kV contact ESD protection with pi-filter	IP4225CZ10	SOT457 (SC-74)	2.9 x 1.5 x 1.0
HDMI	4	-	-	1 pF	-	ESD protection	PRTR5V0U4D	SOT457 (SC-74)	2.9 x 1.5 x 1.0
		-	-	1 pF	-	ESD protection	<b>PRTR5V0U4Y</b>	SOT363 (SC-88)	2.0 x 1.25 x 0.95
		-	-	0.7 pF	-	ESD protection	<b>IP4280CZ10</b>	SOT552 (TSSOP10)	3.0 x 3.0 x 1.1
	8	-	-	1 pF	-	ESD protection	PRTR5V0U8S	SOT510 (TSSOP38)	9.7 x 4.4 x 1.1
		yes	yes	0.7 pF	-	level shifter, ESD protection	<b>IP4776CZ38</b>		
		yes	yes	0.7 pF	-	I <sup>2</sup> C buffer, level shifter, ESD protection, back drive protection, CEC buffer	<b><u>IP4778CZ38</u></b>		

types in **bold red** represent new products  
types in **bold red italic underlined** represent products in development