

### Key-Type Selector Switch

### A22K

Install in 22-mm dia. or 25-mm dia.  
Panel Cutout

- Locking lever ensures easy mounting and removal of switch unit
- Increase wiring efficiency and decrease mounting depth with three-row mounting of switch unit contact blocks
- Finger-safe contacts
- Use optional 25-mm dia. ring to install in 25-mm dia. panel cutouts
- Install using either round, forked crimp terminals, or ferrules
- IP65 oil resistant: EN60947-5-1



This product was manufactured at OMRON Izumo. OMRON Izumo has obtained approvals from international certification bodies for its quality system and environmental control system.

## Ordering Information

### ■ CONSTRUCTION

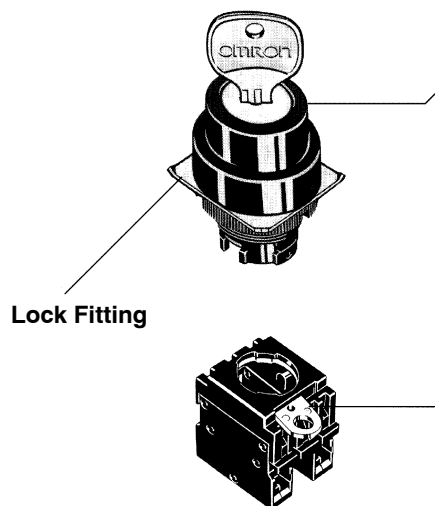

#### Operational Unit

Number of Positions

- 2 Positions/3 Positions

#### Key Release Position

2 Positions



3 Positions



#### Switch Unit

- **Contacts**

SPST-NO, SPST-NC, SPST-NO + SPST-NC, DPST-NO, DPST-NC

## ■ PART NUMBER LEGEND

Shipped as a set which includes the Operational Unit and Switch Unit with contact blocks.

A22K- <sup>1</sup>- <sup>2</sup>

### 1 Number of Positions/Reset Method

Code	Positions	Reset method	Key release position
2ML	2 positions	Maintained	Left
2M			Left and right
2AL		Spring return	Left
3ML	3 positions	Maintained	Left
3M			Left and right
3MC			Center
3AC		Spring return	Center











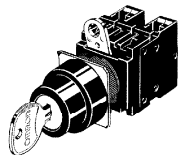



















### 2 Contacts

Code	Description
10	SPST-NO (*)
01	SPST-NC (*)
11	SPST-NO + SPST-NC
20	DPST-NO
02	DPST-NC

Note: \* for models with 2 Positions

Note: SPST= Single Pole, Single Throw  
DPST= Double Pole, Single Throw

## ■ KEY-TYPE SELECTOR SWITCH

Appearance	Positions	Operator type	Contacts	Key release position	Color of Operational Unit	Part number		
Key-type selector switch 	2 positions	Maintained 	SPST-NO		Black	A22K-2ML-10		
						A22K-2M-10		
			SPST-NC			A22K-2ML-01		
						A22K-2M-01		
			SPST-NO + SPST-NC			A22K-2ML-11		
						A22K-2M-11		
			DPST-NO			A22K-2ML-20		
				A22K-2M-20				
		DPST-NC		A22K-2ML-02				
				A22K-2M-02				
		Spring return 	2 positions	Maintained 		SPST-NO		A22K-2AL-10
						SPST-NC		A22K-2AL-01
						SPST-NO + SPST-NC		A22K-2AL-11
						DPST-NO		A22K-2AL-20
	DPST-NC				A22K-2AL-02			
	3 positions	Maintained 	SPST-NO + SPST-NC		A22K-3ML-11			
					A22K-3M-11			
					A22K-3MC-11			
			DPST-NO		A22K-3ML-20			
					A22K-3M-20			
					A22K-3MC-20			
			DPST-NC		A22K-3ML-02			
					A22K-3M-02			
					A22K-3MC-02			
Spring return 		3 positions	Maintained 	SPST-NO + SPST-NC		A22K-3AC-11		
				DPST-NO		A22K-3AC-20		
				DPST-NC		A22K-3AC-02		

# Dimensions

Unit: mm (inch)

## KEY-TYPE SELECTOR SWITCH

A22K

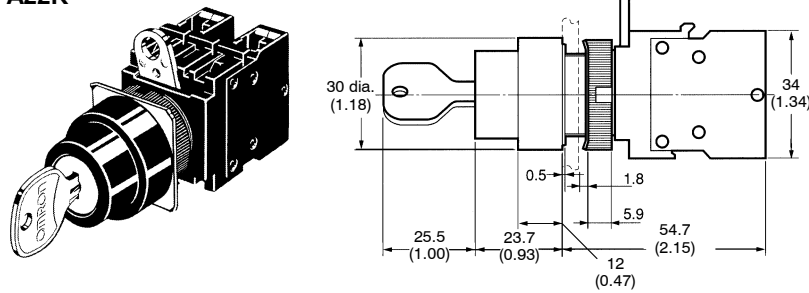

## TERMINAL ARRANGEMENT

### Terminal Arrangement (Bottom View)

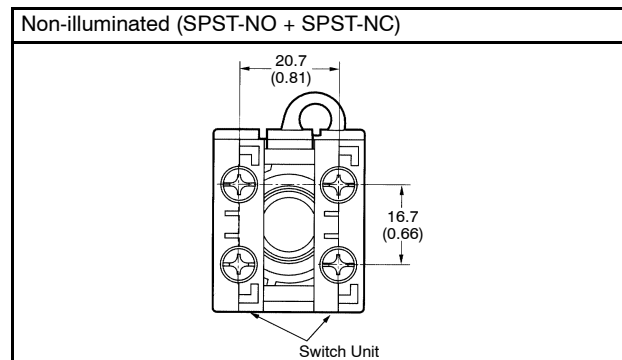

## TERMINAL CONNECTION

Type	Terminal connection
Non-illuminated	<p>Bottom view</p> <p>The diagram shows a common terminal (1) connected to a normally open terminal (2) and a normally closed terminal (3). Terminal 4 is shown as an additional terminal.</p>

Note: The above terminal connection diagrams are examples for SPST-NO + SPST-NC.

## PANEL CUTOUT DIMENSIONS

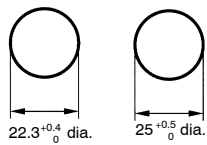













Note: When applying a coating such as paint to a panel, the dimensions should be those after the application of the coating.













A lock fitting is provided as a standard item.

**CONTACT CONFIGURATION**

**2-Position Type**

Knob position	SPST-NO	SPST-NC	SPST-NO + SPST-NC	DPST-NO	DPST-NC
					
					

**3-Position Type**

Knob position	SPST-NO + SPST-NC	DPST-NO	DPST-NC
			
			
			

Note: For additional specifications and information refer to the *Common to all assemblies* section at the end of this publication.

**NOTE: DIMENSIONS SHOWN ARE IN MILLIMETERS. To convert millimeters to inches divide by 25.4.**

**OMRON**<sup>®</sup>

**OMRON ELECTRONICS LLC**

One East Commerce Drive  
Schaumburg, IL 60173

**1-800-55-OMRON**

**OMRON ON-LINE**

Global - <http://www.omron.com>

USA - <http://www.omron.com/oei>

Canada - <http://www.omron.com/oci>

**OMRON CANADA, INC.**

885 Milner Avenue  
Scarborough, Ontario M1B 5V8

**416-286-6465**