



**Pulse**  
A TECHNITROL COMPANY

# LAN Product Guide – Extended Temp



Ideal for Industrial Ethernet applications.



Available for PoE, AutoMDIX, PD, and PSE applications. Custom designs available.



Parts operation temp. (-40° to 85°C). Contact Pulse for 120°C rating.



P = PoE, A = AutoMDIX, NL = RoHS compliance.

DISCRETE MAGNETICS		CONNECTORS WITH INTEGRATED MAGNETICS	
<p><b>10/100</b></p> <p><b>SINGLE:</b></p> <p>HX1148NL<sup>A</sup>    HX1260NL<sup>A</sup> HX1188NL<sup>A</sup>    HX2019NL<sup>A,P</sup></p>	<p><b>Gigabit</b></p> <p><b>SINGLE:</b></p> <p>HX5004NL<sup>A</sup>    HX5009NL<sup>A</sup> HX5007NL<sup>A</sup>    HX5062NL<sup>A</sup></p>	<p><b>10/100</b></p> <p><b>1X1:</b></p> <p>JX00-0027NL<sup>A,P</sup>    JXK0-0025NL<sup>A,P</sup> JX10-0045NL    JXK0-0138NL<sup>A,P</sup></p>	<p><b>Gigabit</b></p> <p><b>1X1:</b></p> <p>JXK0-0036NL<sup>A</sup> JXK0-0161NL<sup>A,P</sup></p>
<p><b>DUAL:</b></p> <p>HX1294NL<sup>A</sup> HX1305NL<sup>A</sup></p>	<p><b>DUAL:</b></p> <p>HX5014NL<sup>A</sup>    HX5200NL<sup>A,P</sup> HX5020NL<sup>A,P</sup>    HX5201NL<sup>A,P</sup> H6080NL</p>	<p><b>1XN:</b></p> <p>JX80-0019NL<sup>A</sup> (1X2) JX80-0033NL<sup>A</sup> (1X4) JX8064D668ANL<sup>A</sup> (1X6) JX8064D688ANL<sup>A</sup> (1X8)</p>	<p><b>1XN:</b></p> <p>JXG0-0129NL<sup>A</sup> (1X2) JXG0-0098NL<sup>A</sup> (1X4) JXG0-0143NL<sup>A</sup> (1X6) JXG0-0029NL<sup>A</sup> (2X8)</p>
<p><b>QUAD:</b></p> <p>HX1203NL    HX1234NL<sup>A</sup> HX1204NL    HX1259NL<sup>A,P</sup></p>	<p><b>QUAD:</b></p> <p>HX5400NL<sup>A,P</sup>    HX5401NL<sup>A,P</sup></p>	<p><b>2XN:</b></p> <p>JX20-0014NL<sup>A</sup> (2X4) JX20-0015NL<sup>A</sup> (2X6) JX20-0016NL<sup>A</sup> (2X8)</p>	<p><b>2XN:</b></p> <p>JXC0-0161NL<sup>A</sup> (2X4) JXC0-0183NL<sup>A</sup> (2X6) JXC0-0319NL<sup>A</sup> (2X8)</p>

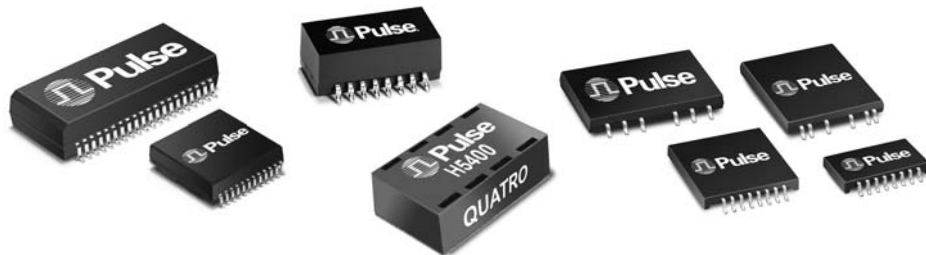







**Pulse**  
A TECHNITROL COMPANY

# LAN Product Guide – Extended Temp

## APPLICATION NOTES

-  Layering ground planes is advisable. Route connector/discrete module ground pins to chassis/analog ground if possible.
-  Keep signal traces from PHY to connector/discrete module as short as possible. If traces exceed 3-4 inches, pay close attention to line impedance imbalance.
-  Using 75 Ω resistors and high voltage cap to chassis ground to terminate cable-side CTs is advisable for best EMI performance (included in most connector solutions).
-  Follow PHY manufacturer's application notes for further layout considerations.

### 10/100 APPLICATION CIRCUIT

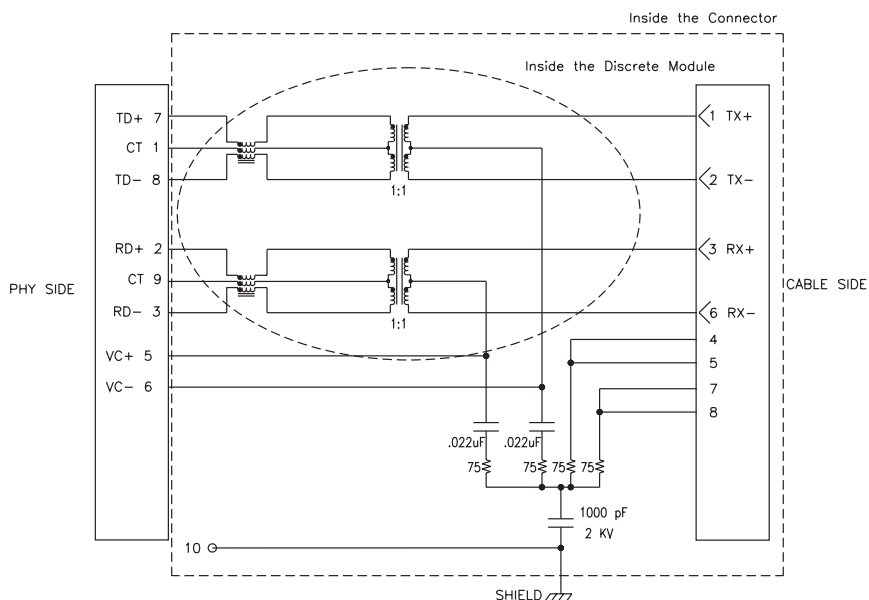

### GIGABIT APPLICATION CIRCUIT

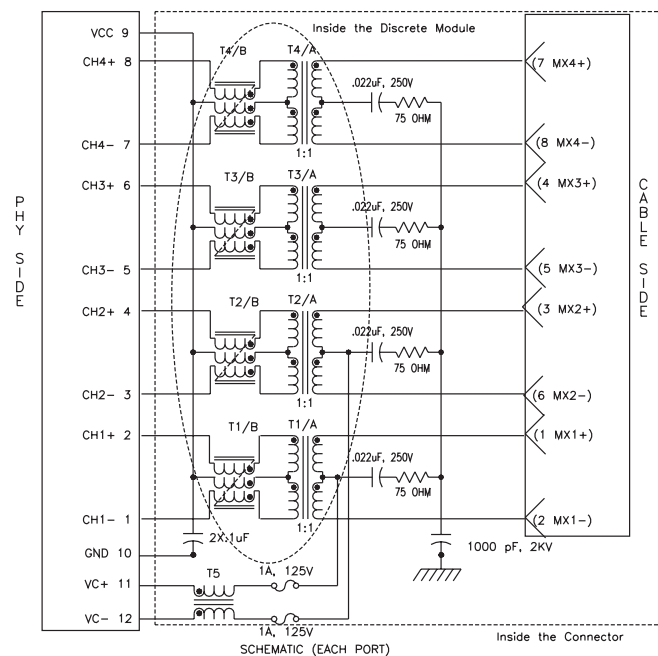

### For More Information:

#### Pulse Worldwide Headquarters

12220 World Trade Dr.  
San Diego, CA 92128  
U.S.A.

[www.pulseeng.com](http://www.pulseeng.com)

Tel: 858 674 8100  
Fax: 858 674 8262

#### Pulse Europe

Einsteinstrasse 1  
D-71083 Herrenberg  
Germany

Tel: 49 7032 7806 116  
Fax: 49 7032 7806 135

#### Pulse China Headquarters

B402, Shenzhen  
Tech-Innovation International  
Tenth Kejinan Rd.  
High-Tech Industrial Park  
Nanshan District, Shenzhen  
China

Tel: 86 755 33966678  
Fax: 86 755 33966700

#### Pulse North China

Room 1503  
XinYin Building  
No. 888 YiShan Rd.  
Shanghai 200233  
China

Tel: 86 21 54643211/2  
Fax: 86 21 54643210

#### Pulse South Asia

150 Kampong Ampat  
#07-01/02  
KA Centre  
Singapore 368324

Tel: 65 6287 8998  
Fax: 65 6280 0080

#### Pulse North Asia

No. 26  
Kao Ching Rd.  
Yang Mei Chen  
Taoyuan Hsien  
Taiwan, R. O. C.

Tel: 886 3 4641811  
Fax: 886 3 4641911

Performance warranty of products offered on this data sheet is limited to the parameters specified. Data is subject to change without notice. Other brand and product names mentioned herein may be trademarks or registered trademarks of their respective owners. © Copyright, 2007. Pulse Engineering, Inc. All rights reserved.