

UNCONTROLLED DOCUMENT

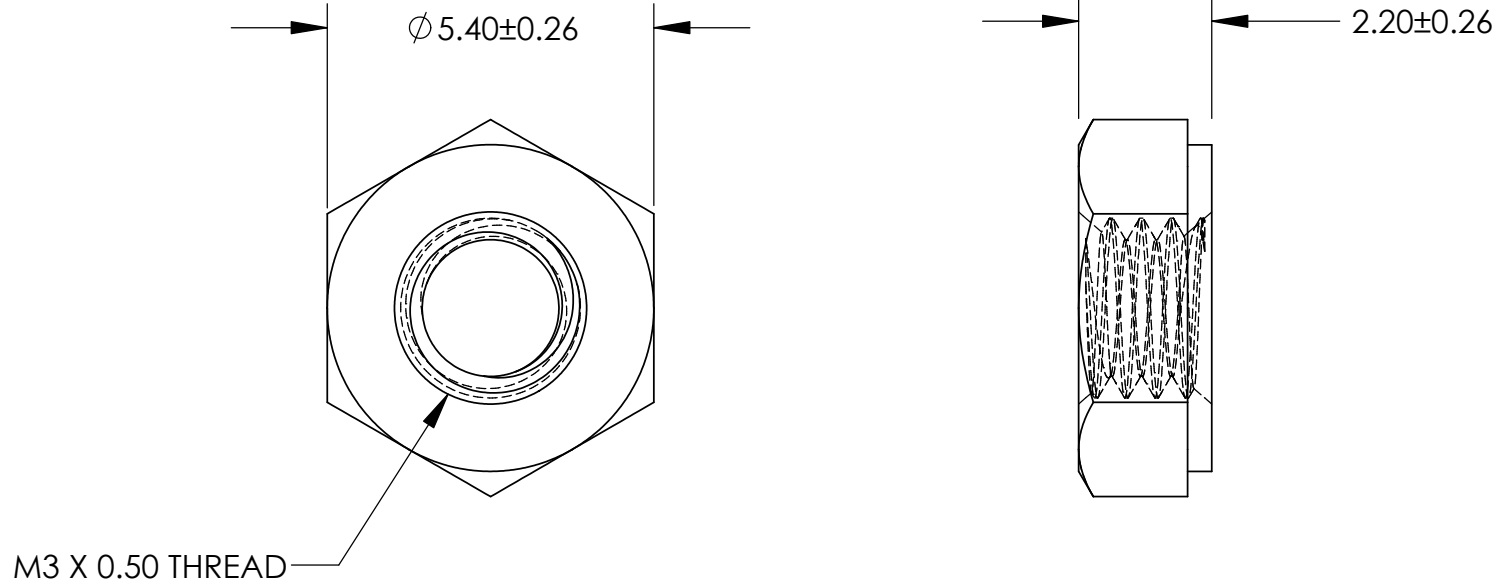

ALL DIMENSIONS ARE IN MILLIMETERS
TOLERANCES UNLESS NOTED

- ±.13MM ON DIMENSIONS THRU 15.88MM
- ±.20MM ON DIMENSIONS 15.89MM THRU 25.41MM
- ±.25MM ON DIMENSIONS 25.42MM THRU 38.10MM
- ±.38MM ON DIMENSIONS LARGER THAN 38.10MM

WE RESERVE THE RIGHT
 TO DISCONTINUE ITEMS,
 CHANGE SPECIFICATIONS
 OR DESIGN AT ANY TIME
 WITHOUT NOTICE AND
 WITHOUT INCURRING
 ANY OBLIGATIONS

| | | |
|---|-------|-----------|
| PROPERTY OF | | |
| MICRO PLASTICS INC. | | |
| CATALOG DRAWING METRIC HEX NUT MICRO P/N 04M030050HN DWG. # 04M030050HN FILE SERVER\ENG\WEB | | |
| MATERIAL: | | 6/6 NYLON |
| DATE | SCALE | TA |
| | 8:1 | |