

micro:bit Breakout Board Hookup Guide

Introduction

The micro:bit, by itself, offers a vast array of possibilities and potential projects, considering it includes an onboard temperature sensor, accelerometer, compass, LED array, Bluetooth radio, and more. However, when you're ready to branch out beyond those initial capabilities, like connecting to an SD card for logging, or taking advantage of one of our many Qwiic boards, you'll need to break out some of the pins on the micro:bit's card edge connector. For that, we've got you covered with the micro:bit Breakout Board.

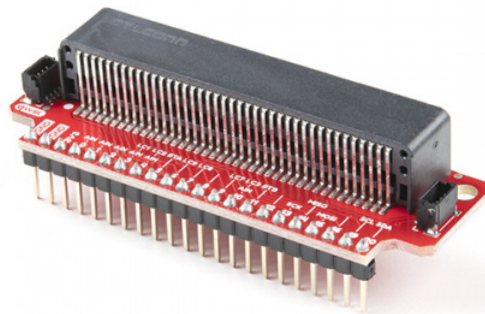

SparkFun Qwiic micro:bit Breakout (with Headers)

🕒 BOB-16446

There's also a version without headers, if you care to solder your own or use wires instead.

Required Materials

To follow along with this project tutorial, you will need the following materials:

micro:bit Breakout Board Hookup Guide SparkFun Wish List

SparkFun Qwiic micro:bit Breakout (with Headers)
BOB-16446



The SparkFun micro:bit Breakout is a board that connects to the BBC micro:bit and expands the capabilities of the ...

LED - RGB Diffused Common Cathode

COM-09264
(3) Resistor 330 Ohm 1/6th Watt PTH
Ever hear of a thing called RGB? Red, Green, Blue? How about an RGB LED? These 5mm units have four pins - ...
COM-08377

1/6th Watt, +/- 5% tolerance PTH resistors. Commonly used in breadboards and perf boards, these 330Ohm resist...



Breadboard - Self-Adhesive (White)

PRT-12002
This is your tried and true white solderless breadboard. It has 2 power buses, 10 columns, and 30 rows - a total of ...



Jumper Wires - Connected 6" (M/M, 20 pack)

PRT-12795
These are 6" long jumper wires with male connectors on both ends. Use these to jumper from any female header o...



micro:bit Board

DEV-14208
The BBC micro:bit is a pocket-sized computer that lets you get creative with digital technology. Each order contains...

Suggested Reading

If you have not yet used the micro:bit, check out this guide first.

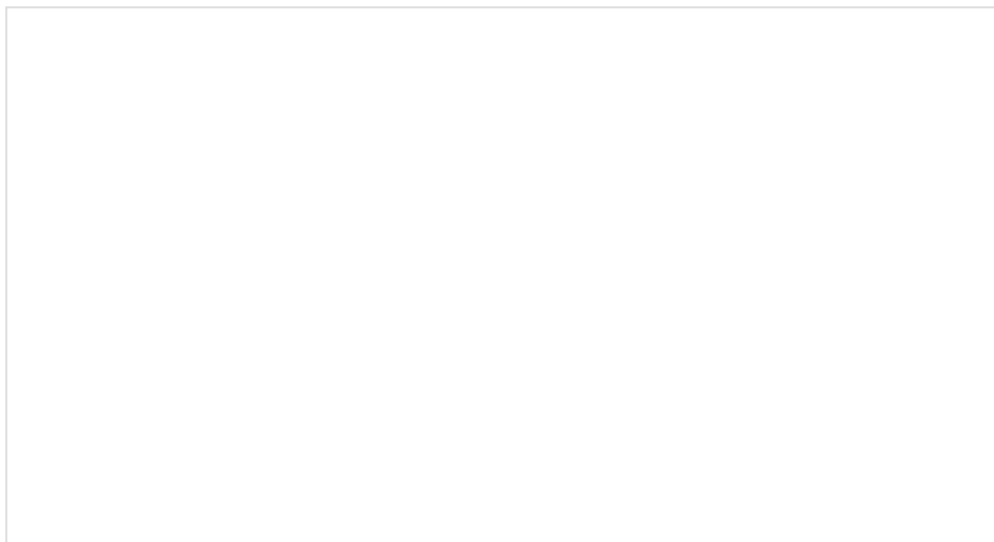

Getting Started with the micro:bit

MARCH 21, 2017

The BBC micro:bit is a compact, powerful programming tool that requires no software installation. Read on to learn how to use it YOUR way!

If you aren't familiar with the Qwiic system and plan to use the Qwiic connectors on this breakout board, we recommend reading here for an overview.



Qwiic Connect System

If you aren't familiar with the following concepts, we recommend checking out these tutorials before continuing.

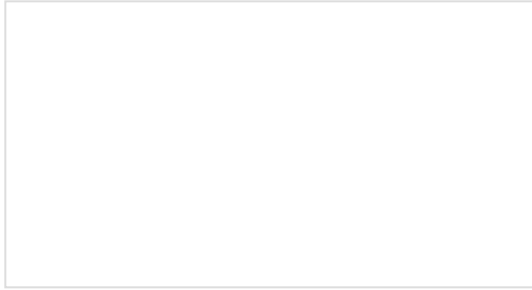

How to Solder: Through-Hole Soldering

This tutorial covers everything you need to know about through-hole soldering.

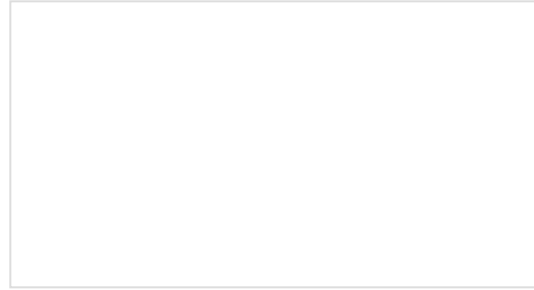

How to Use a Breadboard

Welcome to the wonderful world of breadboards. Here we will learn what a breadboard is and how to use one to build your very first circuit.

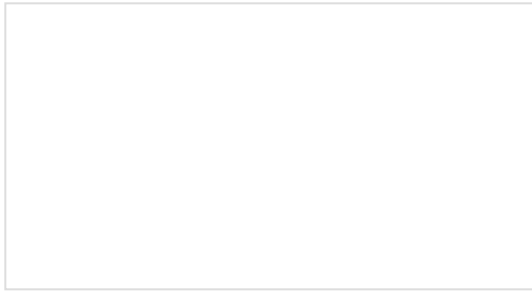

Resistors

A tutorial on all things resistors. What is a resistor, how do they behave in parallel/series, decoding the resistor color codes, and resistor applications.

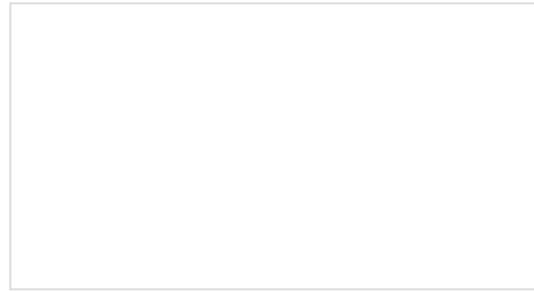

Light-Emitting Diodes (LEDs)

Learn the basics about LEDs as well as some more advanced topics to help you calculate requirements for projects containing many LEDs.

Hardware Overview

The micro:bit Breakout board allows you to utilize all of the pins on the micro:bit and opens up some previously inaccessible communication ports, like I²C and SPI.

Pins

Most of the micro:bit's pins can be configured for one or more functions.

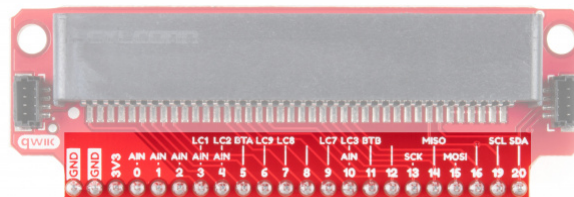

Pin	Function 1	Function 2	Description
-----	------------	------------	-------------

GND			Ground
GND			Ground
3V3			3.3V
0	Analog In		Connected to large pin 0
1	Analog In		Connected to large pin 1
2	Analog In		Connected to large pin 2
3	Analog In	LED Column 1	Controls part of LED array
4	Analog In	LED Column 2	Controls part of LED array
5		Button A	Connected to Button A on micro:bit
6		LED Column 9	Controls part of LED array
7		LED Column 8	Controls part of LED array
8			Open GPIO pin
9		LED Column 7	Controls part of LED array
10	Analog In	LED Column 3	Controls part of LED array
11		Button B	Connected to Button B on micro:bit
12			Open GPIO pin
13	SCK		GPIO or SPI clock
14	MISO		GPIO or SPI MISO
15	MOSI		GPIO or SPI MOSI
16			Open GPIO pin
19	SCL		GPIO or I ² clock
20	SDA		GPIO or I ² data

Power Pin

The pin listed as **3V3** can be used as an input (regulated 3.3V, do not exceed 3.6V!) or an output if you plug a battery pack or USB into the micro:bit.

LCn Pins

The pins labeled with LCn (e.g. LC1, LC8) refer to pins that are used to control the LED array on the front of the micro:bit. You can use them as GPIO, but you'll often get weird patterns to show up on the LEDs, or when you write to the LED array, you may see unexpected behavior. If you use them as GPIO, we recommend disabling the LED display.

Qwiic Connectors

We've added a couple of Qwiic connectors on either side of the breakout board to take advantage of the I²C bus. For more information on the qwiic system, head on over to the [Qwiic Connect System Landing Page](#).

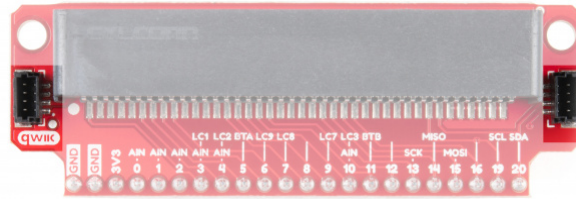

Board Outline

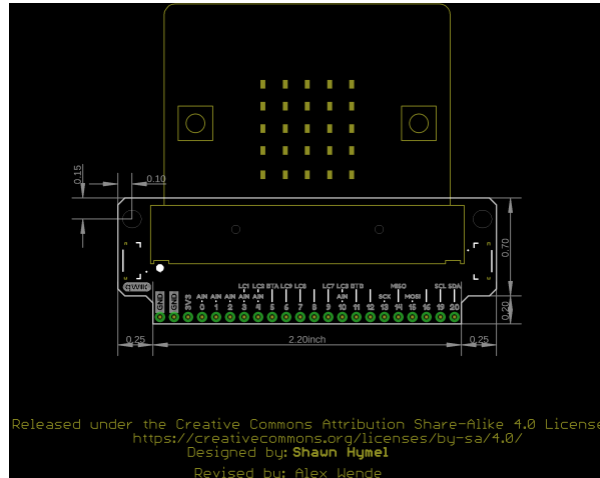

Click on the image for a closer view

Hardware Assembly

Attach Headers

If you have the version of the breakout board without headers, solder some breakaway headers to the board. You can also solder wire directly to the breakout.



Build Example Circuit

Note: The micro:bit must be facing up in order to make electrical connections to the pins.

To begin, let's light up an RGB LED. Attach the micro:bit to the breakout board, place the breakout board onto a breadboard, and connect an RGB LED through 330 Ω resistors. Use the image below to aid you in wire up the circuit.

Remember, LEDs are polarized parts and can only work properly in one orientation. The longest leg of the LED goes where the black GND wire is in the circuit.

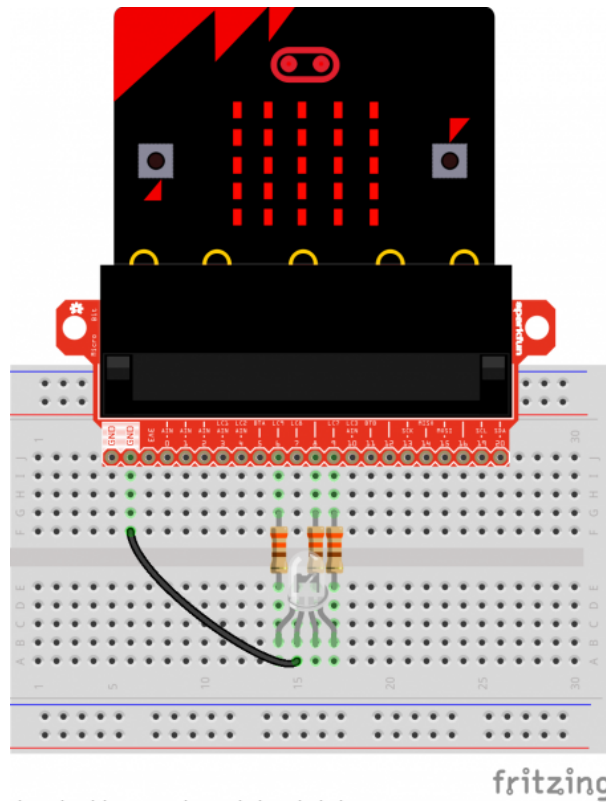

Having a hard time seeing the circuit? Click on the wiring diagram for a closer look.

Example: Cycling Colors on an RGB LED

You can download the code from the emulator, or check out the project's page here:



```
on start
  led enable false
  analog write pin P6 (write only) to 0
  analog write pin P8 (write only) to 0
  forever
    P9 (write only) to 0
    for [ ] to [3071]
```

Copy the `.hex` file to your micro:bit drive, and you should see a fancy array of colors appear on your LED!

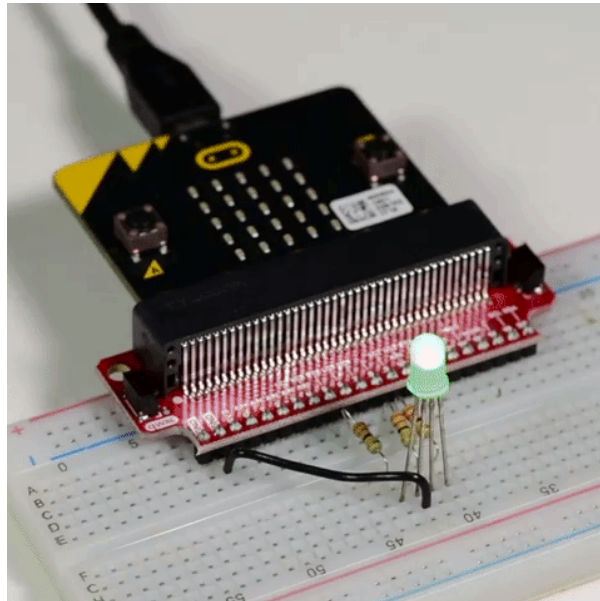

Resources and Going Further

With the micro:bit breakout board, you can start introducing more sensors, lights, and motors into your project! For more information, check out these resources:

- [Schematic](#)
- [Eagle Files](#)
- [GitHub Hardware Repo](#)
- [micro:bit Main Site](#)
- [Microsoft MakeCode](#)
- [MicroPython for micro:bit Editor](#)
- [Qwiic Connect System](#)

Need some inspiration for your next project? Check out some of these related tutorials:

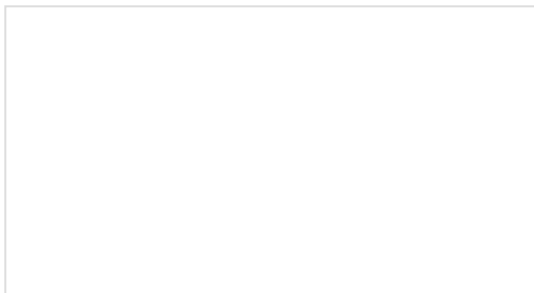

MS5803-14BA Pressure Sensor Hookup Guide
Breakout of MS5803-14BA Pressure Sensor to measure the absolute pressure of the fluid around them to determine altitude, water depth, or any other tasks that require an accurate pressure reading. This

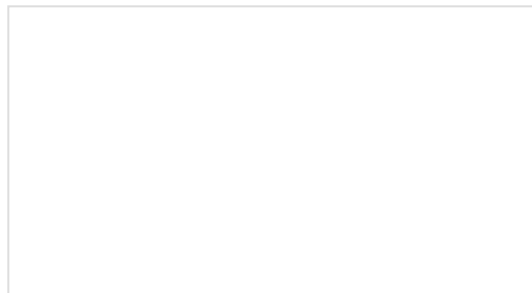

Hackers in Residence - The ElectricBone
Drum machines and keyboards have been the standard for making digital music, but how do you make electronic music if you're trained to play the trombone? One of our Hackers in Residence, Carlos

includes air, water, and anything else that acts like a viscous fluid.

Mello, took it upon himself to find a solution to that very question.

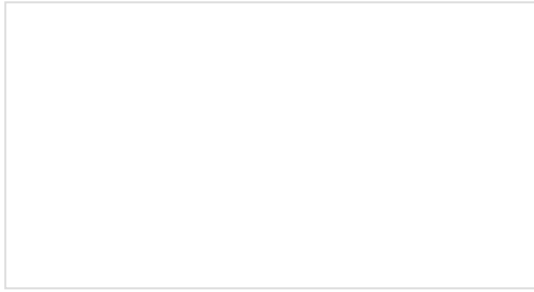

Electret Mic Breakout Board Hookup Guide
An introduction to working with the Electret Mic Breakout Board.

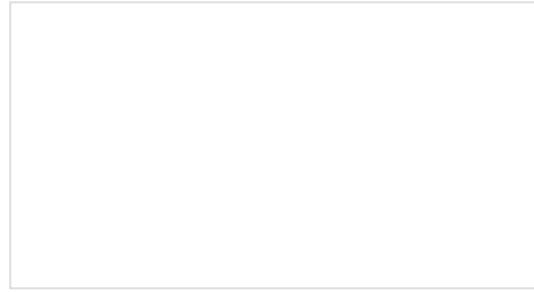

OpenPIR Hookup Guide
How to use and customize the SparkFun OpenPIR motion sensor.

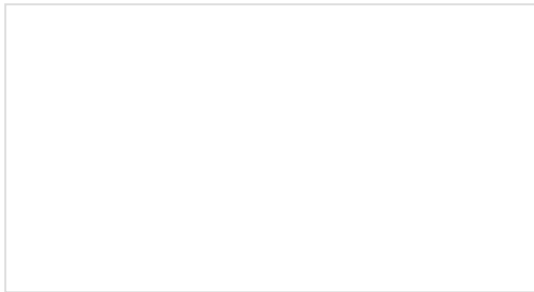

SparkFun GPS Breakout (ZOE-M8Q and SAM-M8Q) Hookup Guide
The SparkFun ZOE-M8Q and SAM-M8Q are two similarly powerful GPS units but with different project applications. We'll compare both chips before getting each up and running.

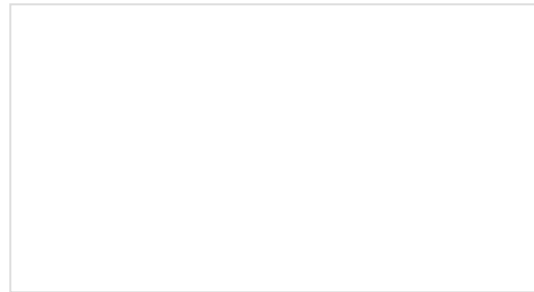

Basic Servo Control for Beginners
An introductory tutorial demonstrating several ways to use and interact with servo motors!

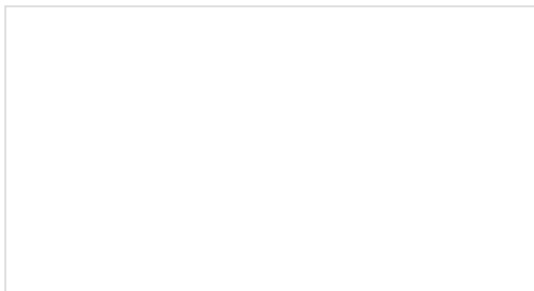

SparkFun MicroMod Input and Display Carrier Board Hookup Guide
A short Hookup Guide to get started with the SparkFun MicroMod Input and Display Carrier Board

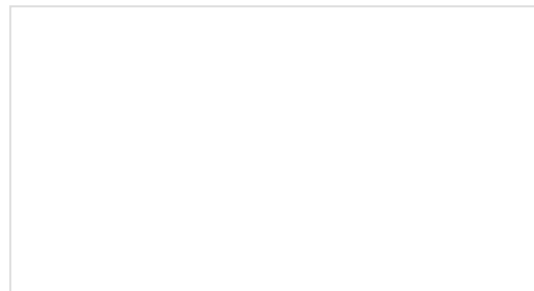

Qwiic Haptic Driver DA7280 Hookup Guide
The Qwiic Haptic Driver includes an itty-bitty, Linear Resonant Actuator (LRA) vibration motor and Dialog Semiconductor's DA7280 motor driver IC for applications that require haptic feedback.