

---

# NI-9235

# Specifications

---

2022-10-07

# Contents

NI-9235 Datasheet..... 3

# NI-9235 Datasheet

- Spring terminal connectivity
- 60 V DC, CAT I, channel-to-earth isolation
- 8 channels, 10 kS/s per channel, simultaneous dynamic strain analog input
- $\pm 29.4$  mV/V input range, 24-bit resolution
- Built-in voltage excitation for quarter-bridge sensors
- 120  $\Omega$  strain gage measurements
- -40 °C to 70 °C operating range, 5 g vibration, 50 g shock

NI-9235 quarter-bridge strain gage modules are designed for higher-channel-count, dynamic strain measurement systems for CompactDAQ or CompactRIO. With eight simultaneous channels per module, you can make more measurements with a smaller, more channel-dense system. Simultaneous sampling is important for higher-speed acquisitions where it is necessary to compare results from different locations at a particular instant in time, such as impact tests.

C SERIES SIMULTANEOUS BRIDGE MODULE COMPARISON

Model	Channels	Sample Rate	Resolution	Connectivity	Simultaneous Supported Bridges
NI 9218	2	51.2 kS/s/ch	24 bits	LEMO, 9-pin DSUB	Quarter, Half, Full
NI 9219	4	100 S/s/ch	24 bits	Spring Terminal	Quarter, Half, Full
NI 9235	8	10 kS/s/ch	24 bits	Spring Terminal	120 $\Omega$ Quarter Bridge
NI 9236	8	10 kS/s/ch	24 bits	Spring Terminal	350 $\Omega$ Quarter Bridge
NI 9237	4	50 kS/s/ch	24 bits	RJ-50, DSUB	Quarter, Half, Full

## NI C Series Overview



NI provides more than 100 C Series modules for measurement, control, and communication applications. C Series modules can connect to any sensor or bus and allow for high-accuracy measurements that meet the demands of advanced data acquisition and control applications.

- Measurement-specific signal conditioning that connects to an array of sensors and signals
- Isolation options such as bank-to-bank, channel-to-channel, and channel-to-earth ground
- -40 °C to 70 °C temperature range to meet a variety of application and environmental needs
- Hot-swappable

The majority of C Series modules are supported in both CompactRIO and CompactDAQ platforms and you can move modules from one platform to the other with no modification.

## CompactRIO



CompactRIO combines an open-embedded architecture with small size, extreme ruggedness, and C Series modules in a platform powered by the NI LabVIEW reconfigurable I/O (RIO) architecture. Each system contains an FPGA for custom timing, triggering, and processing with a wide array of available modular I/O to meet any embedded application requirement.

## CompactDAQ

CompactDAQ is a portable, rugged data acquisition platform that integrates connectivity, data acquisition, and signal conditioning into modular I/O for directly interfacing to any sensor or signal. Using CompactDAQ with LabVIEW, you can easily customize how you acquire, analyze, visualize, and manage your measurement data.



## Software

### LabVIEW Professional Development System for Windows

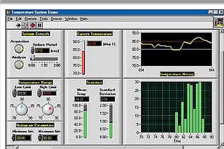

- Use advanced software tools for large project development
- Generate code automatically using DAQ Assistant and Instrument I/O Assistant
- Use advanced measurement analysis and digital signal processing
- Take advantage of open connectivity with DLLs, ActiveX, and .NET objects
- Build DLLs, executables, and MSI installers

### NI LabVIEW FPGA Module

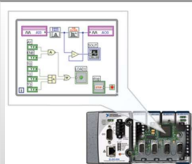

- Design FPGA applications for NI RIO hardware
- Program with the same graphical environment used for desktop and real-time applications
- Execute control algorithms with loop rates up to 300 MHz
- Implement custom timing and triggering logic, digital protocols, and DSP algorithms
- Incorporate existing HDL code and third-party IP including Xilinx IP generator functions
- Purchase as part of the LabVIEW Embedded Control and Monitoring Suite

## NI LabVIEW Real-Time Module

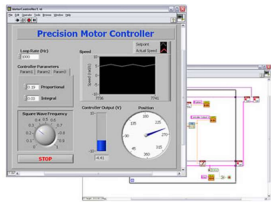

- Design deterministic real-time applications with LabVIEW graphical programming
- Download to dedicated NI or third-party hardware for reliable execution and a wide selection of I/O
- Take advantage of built-in PID control, signal processing, and analysis functions
- Automatically take advantage of multicore CPUs or set processor affinity manually
- Take advantage of real-time OS, development and debugging support, and board support
- Purchase individually or as part of a LabVIEW suite

## Circuitry

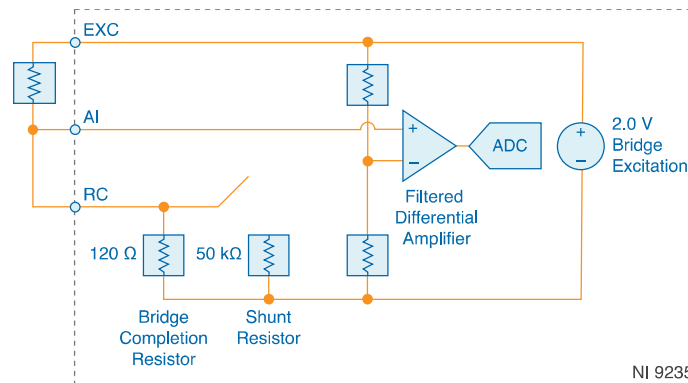

- Each channel on the NI-9235 has an independent 24-bit ADC and input amplifier that enables you to sample signals from all eight channels simultaneously.
- The NI-9235 is isolated from earth ground. However, the individual channels are not isolated from each other. The EXC terminals all connect internally to a common excitation supply.

## Lead Wire Desensitization

Quarter-bridge measurements are inherently sensitive to accuracy degradation due to the lead resistance of wiring from the sensor to the measurement device. For a given change in the gage resistance, the total effective resistance changes slightly less. Accordingly, the measured mV/V reading is less than its true value. However, you can use shunt calibration to quantify the lead wire resistance, and can then design the software application to correct subsequent readings for this gain error. The gain error caused by a lead wire equals  $R_L/R_G$ , where  $R_L$  is the lead wire resistance, and  $R_G$  is the quarter-bridge completion resistance.

## Shunt Calibration

Shunt calibration simulates strain input by shunting, or connecting, a large resistor across one arm of the bridge, a specific change occurs in the bridge voltage ratio.

The NI-9235 shunt calibration circuitry consists of a precision resistor and a software-enabled switch, connected across the internal quarter-bridge completion resistor. Each input channel has a unique shunt calibration resistor that can operate independently. With the connected sensor in a stable, typically unloaded state, you can measure the output of the bridge before and after the shunt calibration. You can compare the measured reading change to the shunt calibration output value to verify system setup or compensate for quarter-bridge lead wire resistance error. Visit [ni.com/info](http://ni.com/info) and enter `lwcomp` for information about lead wire compensation.

## Excitation Voltage

The NI-9235 provides a constant excitation supply voltage to each channel. The excitation supply provides sufficient output current to power all eight channels at minimum resistance. The excitation supply retains regulation even if one channel experiences a gage short. If more than one channel has a gage short, the excitation supply enters a current limit state and the excitation voltage falls accordingly.

## Filtering

The NI-9235 uses a combination of analog and digital filtering to provide an accurate representation of in-band signals and reject out-of-band signals. The filters discriminate between signals based on the frequency range, or bandwidth, of the signal. The three important bandwidths to consider are the passband, the stopband, and the anti-imaging bandwidth.

The NI-9235 represents signals within the passband, as quantified primarily by passband ripple and phase nonlinearity. All signals that appear in the alias-free bandwidth are either unaliased signals or signals that have been filtered by at least the amount of the stopband rejection.

## Passband

The signals within the passband have frequency-dependent gain or attenuation. The small amount of variation in gain with respect to frequency is called the passband flatness. The digital filters of the NI-9235 adjust the frequency range of the passband to match the data rate. Therefore, the amount of gain or attenuation at a given frequency depends on the data rate.

Figure 1. Typical Passband Response for the NI-9235

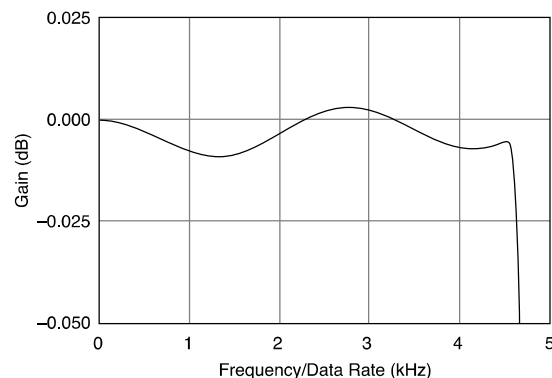

## Stopband

The filter significantly attenuates all signals above the stopband frequency. The primary goal of the filter is to prevent aliasing. Therefore, the stopband frequency scales precisely with the data rate. The stopband rejection is the minimum amount



of attenuation applied by the filter to all signals with frequencies within the stopband.

## Alias-Free Bandwidth

Any signals that appear in the alias-free bandwidth are not aliased artifacts of signals at a higher frequency. The alias-free bandwidth is defined by the ability of the filter to reject frequencies above the stopband frequency. The alias-free bandwidth is equal to the data rate minus the stopband frequency.

## Data Rates

The frequency of a master timebase ( $f_M$ ) controls the data rate ( $f_s$ ) of the NI-9235. The NI-9235 includes an internal master timebase with a frequency of 12.8 MHz, but the module also can accept an external master timebase or export its own master timebase. To synchronize the data rate of an NI-9235 with other modules that use master timebases to control sampling, all of the modules must share a single master timebase source.

The following equation provides the available data rates of the NI-9235:

$$f_s = \frac{f_M \div 256}{n}$$

$$f_s = \frac{f_M \div 256}{n}$$

where  $n$  is any integer from 1 to 31.

However, the data rate must remain within the appropriate data rate range. When using the internal master timebase of 12.8 MHz, the result is data rates of 10 kS/s, 8.333 kS/s, 7.143 kS/s, and so on down to 794 S/s, depending on the value of  $n$ . When using an external timebase with a frequency other than 12.8 MHz, the NI-9235 has a different set of data rates.

**Note** The NI 9151 R Series Expansion chassis does not support sharing timebases between modules.

## NI-9235 Specifications

The following specifications are typical for the range -40 °C to 70 °C unless otherwise noted.

**Caution** Do not operate the NI-9235 in a manner not specified in this document. Product misuse can result in a hazard. You can compromise the safety protection built into the product if the product is damaged in any way. If the product is damaged, return it to NI for repair.

### Input Characteristics

Number of channels	8 analog input channels
Quarter-bridge completion	120 $\Omega$ , 10 ppm/°C maximum
ADC resolution	24 bits
Type of ADC	Delta-Sigma (with analog prefiltering)
Sampling mode	Simultaneous
<b>Internal master timebase (<math>f_M</math>)</b>	
Frequency	12.8 MHz
Accuracy	$\pm 100$ ppm maximum
<b>Data rate range (<math>f_s</math>) using internal master timebase</b>	
Minimum	794 S/s
Maximum	10 kS/s

<b>Data rate range (<math>f_s</math>) using external master timebase</b>				
Minimum		195.3125 S/s		
Maximum		10.547 kS/s		
Data rates <sup>[1]</sup> ( $f_s$ )		$(f_M \div 256)/n, n = \{2; 4, 5, \dots, 63\}$		
Full-scale range		$\pm 29.4 \text{ mV/V}$ (+62,500 $\mu\epsilon$ /-55,500 $\mu\epsilon$ )		
Scaling coefficient		3.5062 nV/V per LSB		
Overvoltage protection between any two terminals		$\pm 30 \text{ V}$		
Measurement Conditions		Percent of Reading <sup>[2]</sup> (Gain Error)	Percent of Range <sup>[3],[4]</sup> (Offset Error)	
			30 days after cal. ( $\pm 5 \text{ }^\circ\text{C}$ )	1 year after cal. ( $\pm 5 \text{ }^\circ\text{C}$ )
Calibrated	Typical (25 $^\circ\text{C}$ , $\pm 5 \text{ }^\circ\text{C}$ )	0.02%	0.1%	0.15%
	Maximum (-40 $^\circ\text{C}$ to 70 $^\circ\text{C}$ )	0.07%	0.17%	0.4%
Uncalibrated <sup>[5]</sup>	Typical (25 $^\circ\text{C}$ , $\pm 5 \text{ }^\circ\text{C}$ )	0.15%	1.25%	
	Maximum (-40 $^\circ\text{C}$ to 70 $^\circ\text{C}$ )	0.53%	2.14%	

Table 1. Accuracy

<b>Stability</b>			
Gain drift		6 ppm/ $^\circ\text{C}$	
Offset drift		2.2 $\mu\text{V/V}/^\circ\text{C}$	
Input Signal Frequency ( $f_{in}$ )	Gain		Phase
	Typical	Maximum	Maximum
0 to 1 kHz	0.08%	0.11%	$0.34^\circ/\text{kHz} * f_{in}$

Input Signal Frequency ( $f_{in}$ )	Gain		Phase
	Typical	Maximum	Maximum
0 to 4 kHz	0.17%	0.32%	

Table 2. Channel-to-Channel Matching (Calibrated)

<b>Phase nonlinearity</b>	
$f_{in} = 0$ to 1 kHz	$\pm 0.002^\circ$
$f_{in} = 0$ to 4 kHz	$\pm 0.1^\circ$
Input delay	$(39 + 221/1024)/f_s + 12 \mu s$
<b>Passband</b>	
Frequency	$0.45 * f_s$
Flatness ( $f_s = 10$ kS/s)	33 mdB maximum
<b>Stopband</b>	
Frequency	$0.55 * f_s$
Rejection	100 dB
Alias-free bandwidth	$0.45 * f_s$
Oversample rate	$64 * f_s$
Rejection at oversample rate <sup>[6]</sup> ( $f_s = 10$ kS/s)	80 dB @ 640 kHz
<b>Input noise</b>	

$f_s = 1 \text{ kS/s}$	0.38 $\mu\text{V/V RMS}$
$f_s = 10 \text{ kS/s}$	0.85 $\mu\text{V/V RMS}$
SFDR (1 kHz, -60 dBFS)	110 dB
THD (1 kHz, -20 dBFS)	-90 dB
Crosstalk ( $f_{in} = 1 \text{ kHz}$ )	-100 dB
Common-mode voltage, all signals to earth ground	$\pm 60 \text{ VDC}$
CMRR ( $f_{in} = 0 \text{ to } 60 \text{ Hz}$ )	120 dB
MTBF	566,796 hours at 25 °C; Bellcore Issue 2, Method 1, Case 3, Limited Part Stress Method

## Shunt Calibration Characteristics

Measurement Conditions	Percent of Reading (Gain Error)
Typical (25 °C, $\pm 5 \text{ °C}$ )	0.09%
Maximum (-40 °C to 70 °C)	0.22%

Table 3. Shunt Calibration Accuracy

Resistance	50 k $\Omega$
Output value	-599.28 $\mu\text{V/V}$
Temperature drift	15 ppm/°C
Method	Shunt across completion resistor

## Excitation Characteristics

Excitation type	Constant voltage
Excitation value	2.0 V $\pm$ 1%
Maximum output current	80 mA

## Power Requirements

<b>Power consumption from chassis</b>	
Active mode	735 mW maximum
Sleep mode	25 $\mu$ W maximum
<b>Thermal dissipation (at 70 °C)</b>	
Active mode	735 mW maximum
Sleep mode	25 $\mu$ W maximum

## Physical Characteristics

<b>Spring-terminal wiring</b>	
Gauge	copper conductor wire
Wire strip length	of insulation stripped from the end
Temperature rating	

Wires per spring terminal
---------------------------

<b>Connector securement</b>	
-----------------------------	--

Securement type	Screw flanges provided
-----------------	------------------------

Torque for screw flanges
--------------------------

## Safety Voltages

Connect only voltages that are within the following limits:

Between any two terminals	±30 V maximum
<b>Isolation</b>	
Channel-to-channel	None
<b>Channel-to-earth ground</b>	
Continuous	60 V DC, Measurement Category I
Withstand	1,000 V RMS, verified by a 5 s dielectric withstand test

## Hazardous Locations

U.S. (UL)	; ,
Canada (C-UL)	;
Europe (ATEX) and International (IECEX)	DEMKO ATEX

IECEX

## Safety Compliance and Hazardous Locations Standards

This product is designed to meet the requirements of the following electrical equipment safety standards for measurement, control, and laboratory use:

- IEC 61010-1, EN 61010-1
- UL 61010-1, CSA C22.2 No. 61010-1
- EN 60079-0, EN 60079-7
- IEC 60079-0, IEC 60079-7
- UL 60079-0, UL 60079-7
- CSA C22.2 No. 60079-0, CSA C22.2 No. 60079-7

**Note** For safety certifications, refer to the product label or the [Product Certifications and Declarations](#) section.

## Electromagnetic Compatibility

## CE Compliance

- 2014/34/EU; Potentially Explosive Atmospheres (ATEX)

## Product Certifications and Declarations

Refer to the product Declaration of Conformity (DoC) for additional regulatory compliance information. To obtain product certifications and the DoC for NI products, visit [ni.com/product-certifications](https://ni.com/product-certifications), search by model number, and click the appropriate link.



## Shock and Vibration

To meet these specifications, you must panel mount the system.

<b>Operating vibration</b>	
Random	5 g RMS, 10 Hz to 500 Hz
Sinusoidal	5 g, 10 Hz to 500 Hz
Operating shock	30 g, 11 ms half sine; 50 g, 3 ms half sine; 18 shocks at 6 orientations

## Environmental

Refer to the manual for the chassis you are using for more information about meeting these specifications.

Operating temperature (IEC 60068-2-1, IEC 60068-2-2)	-40 °C to 70 °C
Storage temperature (IEC 60068-2-1, IEC 60068-2-2)	-40 °C to 85 °C
Ingress protection	IP40
Operating humidity (IEC 60068-2-30)	10% RH to 90% RH, noncondensing
Storage humidity (IEC 60068-2-30)	5% RH to 95% RH, noncondensing
Pollution Degree	2
Maximum altitude	5,000 m

Indoor use only.

## Environmental Management

NI is committed to designing and manufacturing products in an environmentally responsible manner. NI recognizes that eliminating certain hazardous substances from our products is beneficial to the environment and to NI customers.

For additional environmental information, refer to the **Engineering a Healthy Planet** web page at [ni.com/environment](http://ni.com/environment). This page contains the environmental regulations and directives with which NI complies, as well as other environmental information not included in this document.

## EU and UK Customers

-  **Waste Electrical and Electronic Equipment (WEEE)**—At the end of the product life cycle, all NI products must be disposed of according to local laws and regulations. For more information about how to recycle NI products in your region, visit [ni.com/environment/weee](http://ni.com/environment/weee).

## 电子信息产品污染控制管理办法（中国 RoHS）

-  **中国 RoHS**— NI 符合中国电子信息产品中限制使用某些有害物质指令(RoHS)。关于 NI 中国 RoHS 合规性信息，请登录 [ni.com/environment/rohs\\_china](http://ni.com/environment/rohs_china)。(For information about China RoHS compliance, go to [ni.com/environment/rohs\\_china](http://ni.com/environment/rohs_china).)

## Calibration

You can obtain the calibration certificate and information about calibration services for the NI-9235 at [ni.com/calibration](http://ni.com/calibration).

Calibration interval	1 year
----------------------	--------

<sup>1</sup> The data rate must remain within the appropriate data rate range.

<sup>2</sup> Exclusive of lead wire resistance error.

<sup>3</sup> Range equals 29.4 mV/V.

<sup>4</sup> Calibrated errors represent offset stability following unstrained measurement. Errors include the effect of completion resistor tolerance and drift.

<sup>5</sup> Uncalibrated accuracy refers to the accuracy achieved when acquiring in raw or unscaled modes where the calibration constants stored in the module are not applied to the data.

<sup>6</sup> Rejection by analog prefilter of signal frequencies at oversample rate.